

Screw the legs on the bottom of the sofa, as shown in the schema.

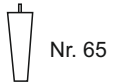

Nr. 65

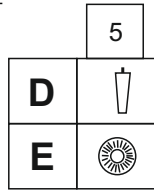

2S

1 set of legs = only 4 pieces



3S

1 set of legs = only 4 pieces



3A / A3

1 set of legs = only 7 pieces

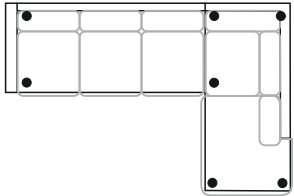

2.5A / A2.5

1 set of legs = only 7 pieces

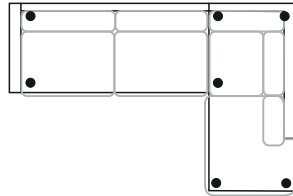

D3A / A3D

1 set of legs = only 11 pieces

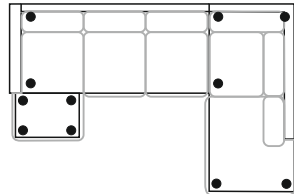



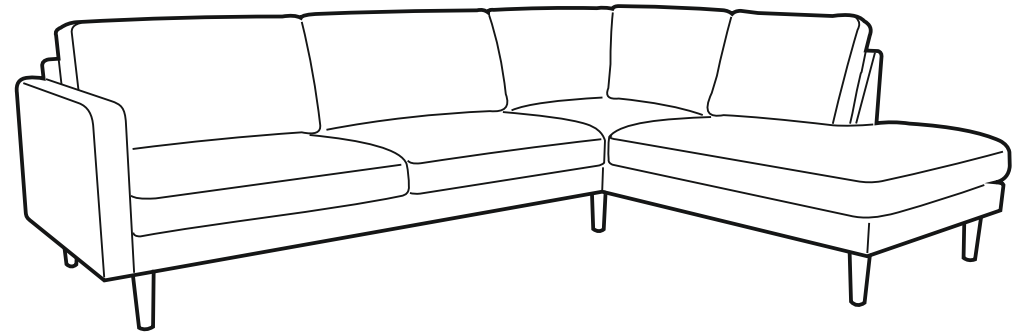
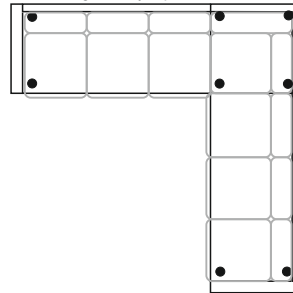

3C3

1 set of legs = only 8 pieces

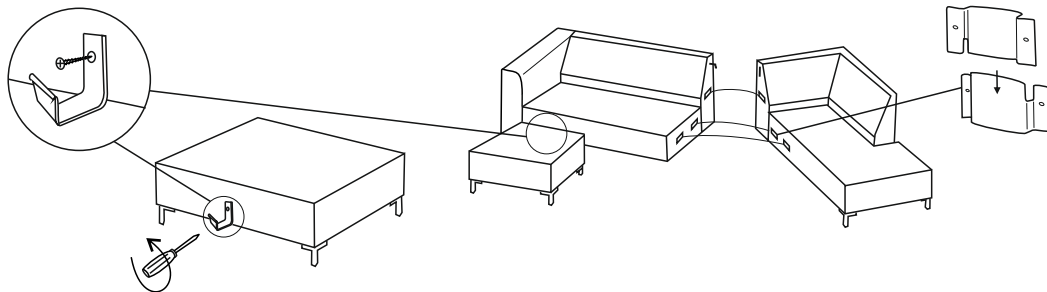

Do not throw away the packing materials until assembly is complete;
From scratching or other damages: assemble this item on a soft surface, such as cardboard or carpet, to protect finish;
Hardware may loosen overtime. Periodically check that all connections are tight;
Protect sofa from an environmental factors such as : heat, direct sunlight and humidity;
Do not use sofa outdoors.
Do not fix the sofa yourself, sofa could be fixed only in our factory, our after-sales service workshop or by licensed and qualified professionals, by using only original replacement parts, otherwise, the warranty could be considered as void.



A	—
B	
C	
D	
E	

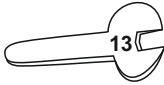

For washers and nuts

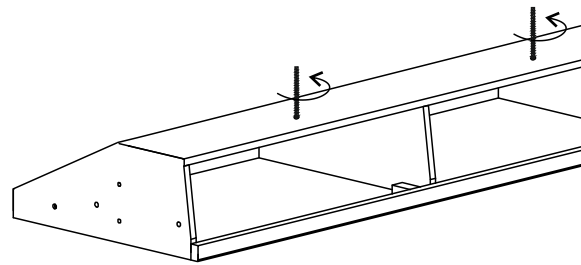

	1
A	—

Place the back on the smooth surface and fasten a bolt in each pre-drilled hole.



	2
B	
C	

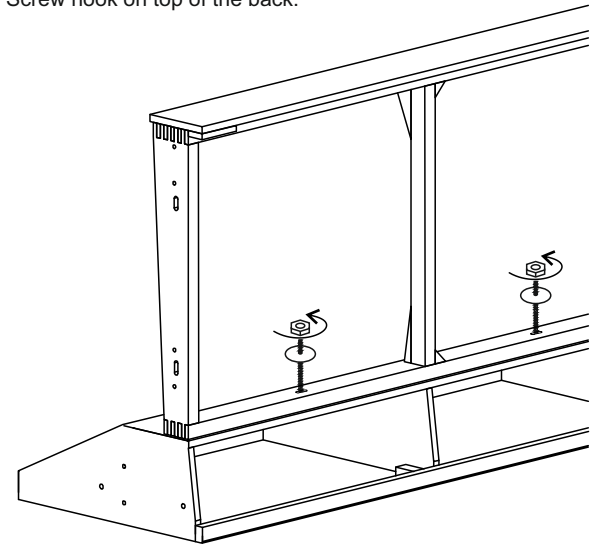

Place the seat in the top of the backabove the bolts, add washers and fasten nuts on each bolt, but keep it loose. Screw hook on top of the back.



	3
A	—

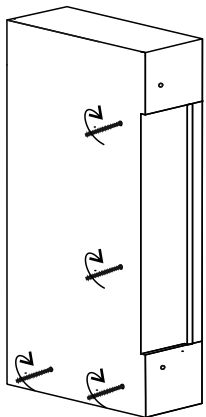

Fasten one bolt in each pre-drilled hole in the armrests.

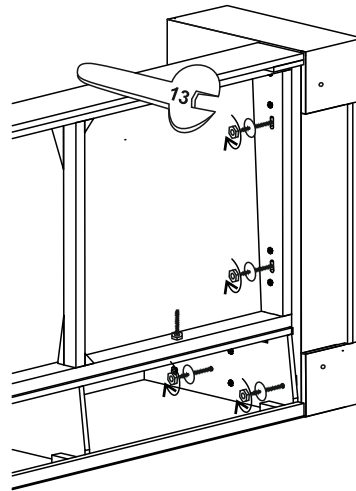

	4
C	
D	

Put the in the armrest together with the backrest and the seat. Fasten nuts on each bolt, but keep it loose.



	5
D	
D	
E	

Screw the legs.

