

RAVELLO BAR1

enfilade - dressoir - cabinet

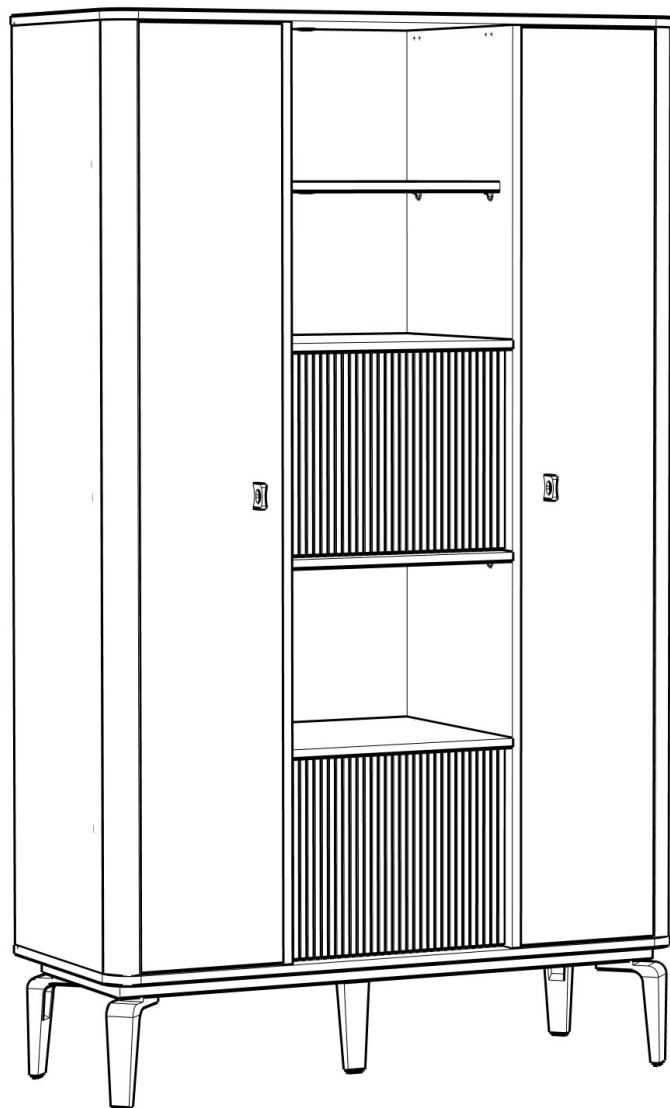
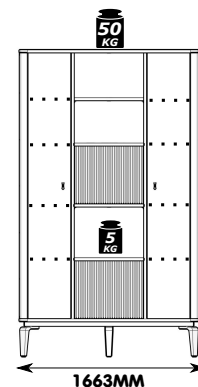
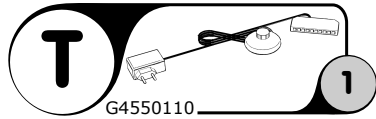
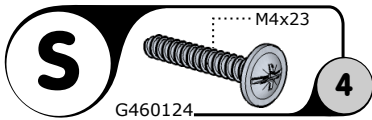
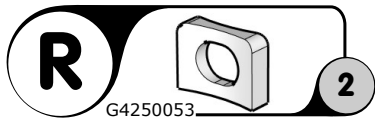
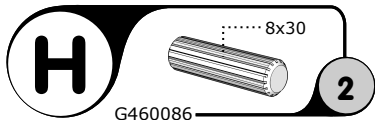
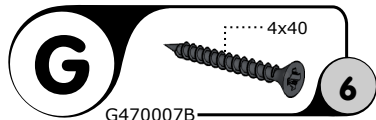
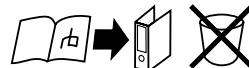

NL**ONDERHOUDSTIPS**

Oppervlakte kunststofdecor houtstructuur. Onderhoud: met lichte vochtige doek reinigen en hierna direct droog wrijven. De meubels zijn niet voor vochtige ruimten (bad, keuken etc.) bestemd. Vocht op het bovenblad direct opnemen. Montagetekening opbergen.

Het meubel moet door een vakkundig persoon, zoals in de handleiding staat beschreven worden gemonteerd. Door verkeerde montage kunnen gevaren ontstaan.

D**HINWEISE FÜR DIE PFLEGE**

Oberflächen Kunststoff-Dekor Holznachbildung. Pflegehinweis: Mit leicht feuchtem Tuch reinigen, sofort trocken nachwischen. Möbel nicht für Feuchträume geeignet (Bad, Küche etc.). Nässe auf Oberfläche unverzüglich wegwischen. Aufbauanleitung aufbewahren.

Das Möbel muss durch eine fachkundige Person entsprechend der Aufbauanleitung montiert werden. Bei fehlerhafter Montage kann es zu Gefahren kommen.

EN**ADVISE ON MAINTENANCE**

All surfaces in laminated wood colour finishes. Maintenance: clean with slightly moistened cloth, wipe dry immediately. Not suited for damp locations (kitchen, bathroom etc.). Wipe off wetness at once. Retain manual instruction.

The unit must be put together by a specialist according to the assembly instructions. Hazards may arise in case of incorrect assembly.

F**CONSEILS D' ENTRETIEN**

Panneaux de particules revêtus d'un film polymère. Entretien: utiliser un chiffon légèrement humide et repasser de suite avec un autre sec. Meuble inadapté aux pièces humides (bain, cuisine etc.). Toute trace de liquide est à essuyer immédiatement. Notice de montage à conserver.

Le meuble doit être monté par une personne spécialisée en la matière, conformément à l'instruction de montage. En cas d'erreur de montage, des dangers peuvent se manifester.

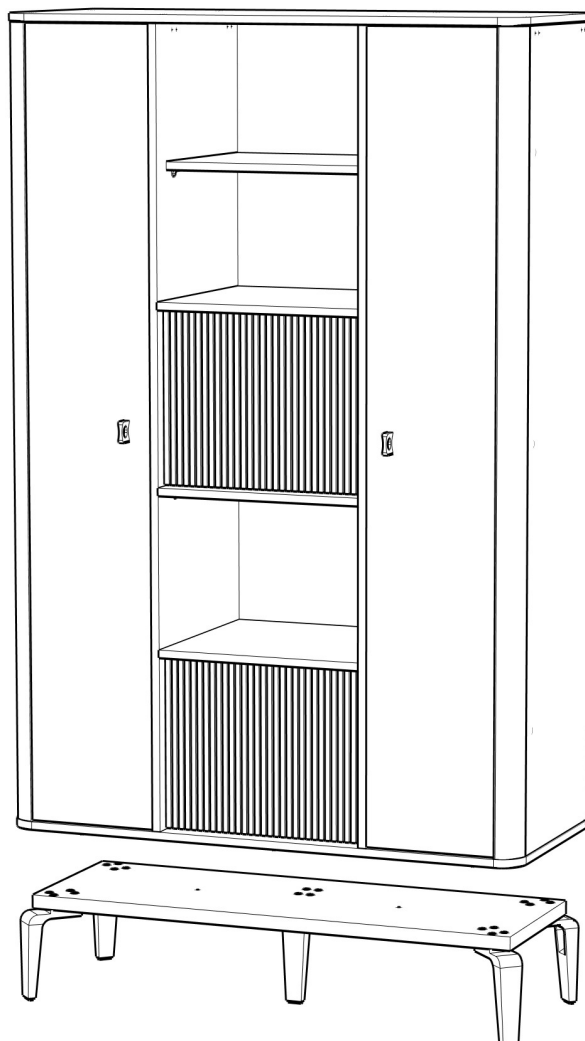
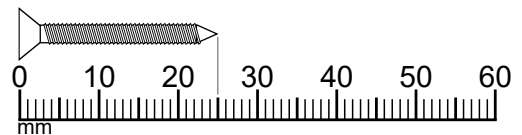
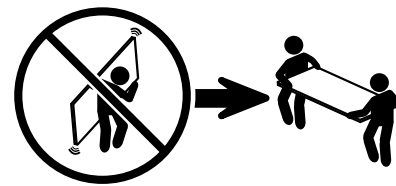
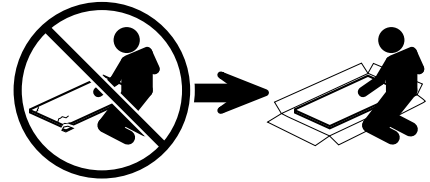

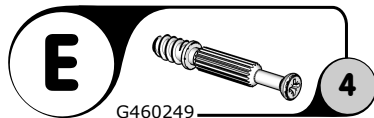
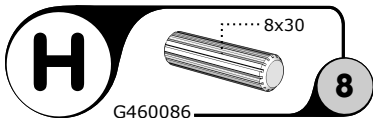
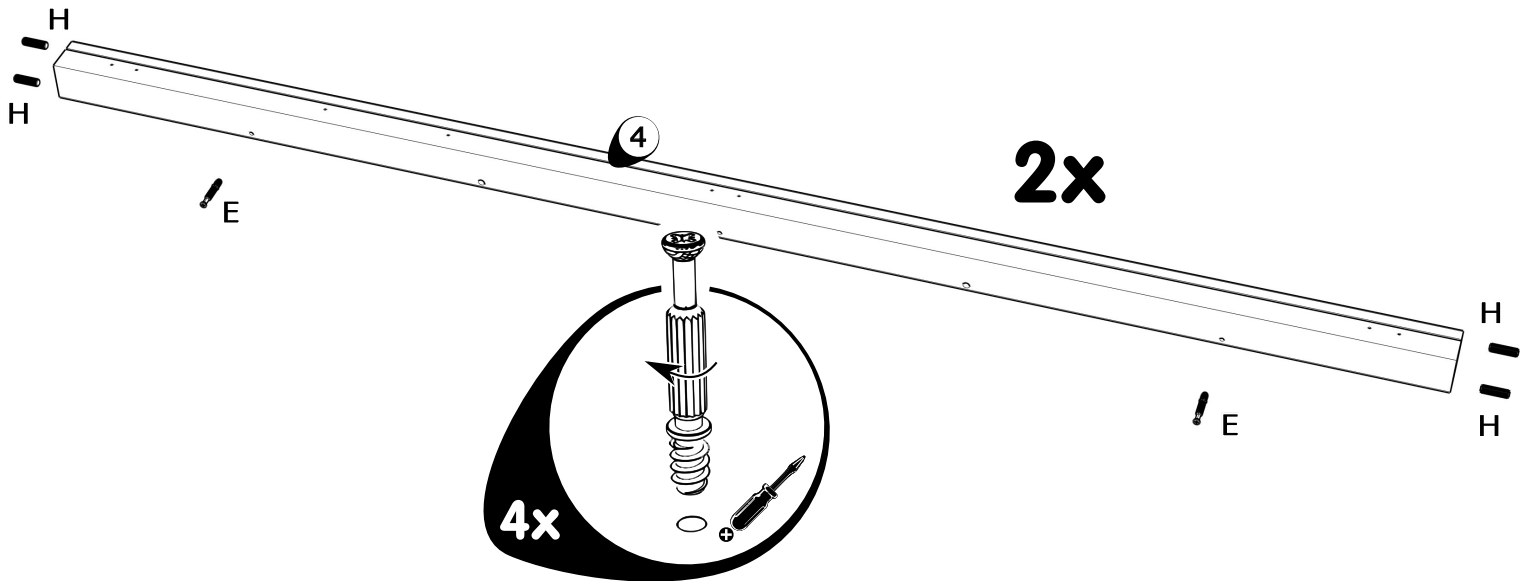
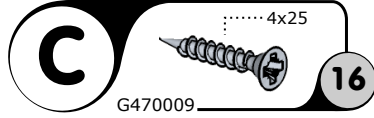
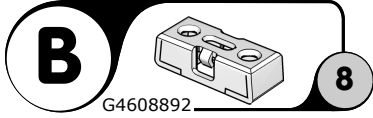
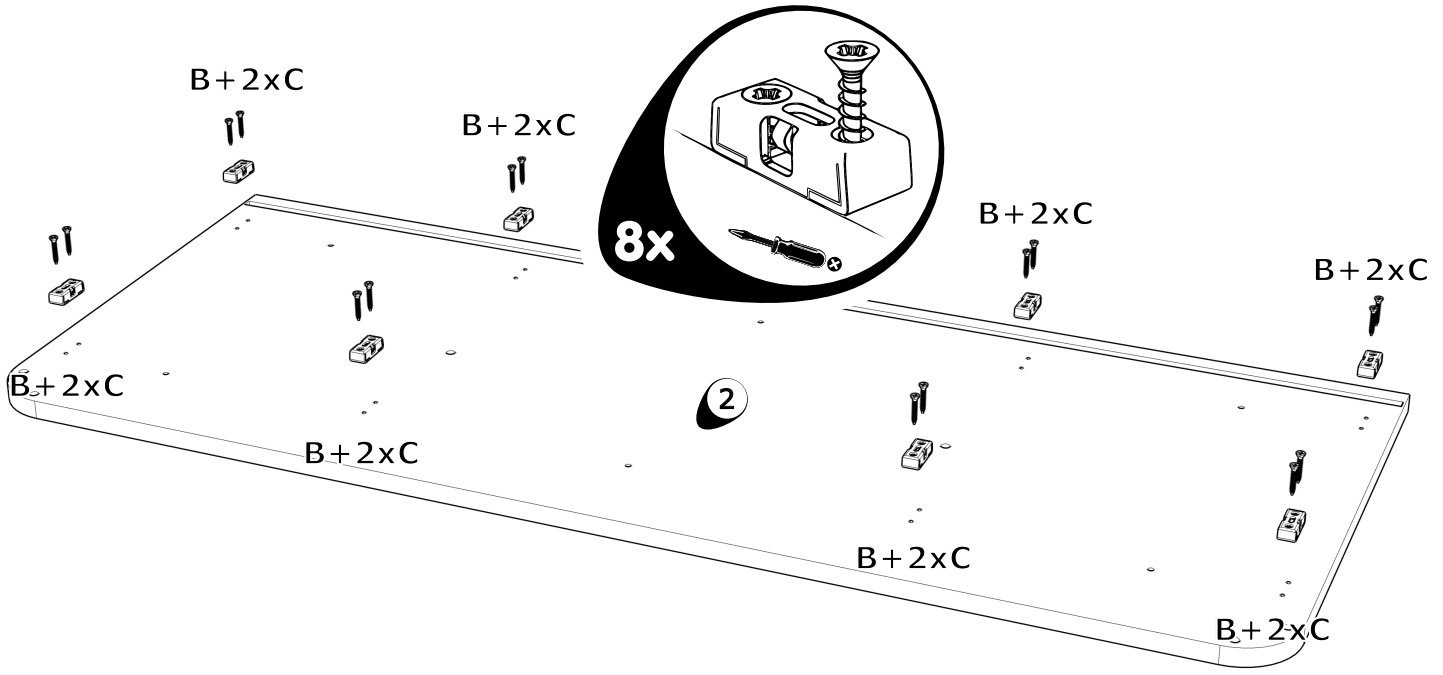

7

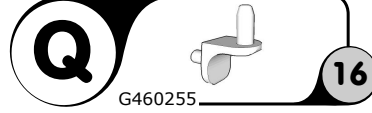
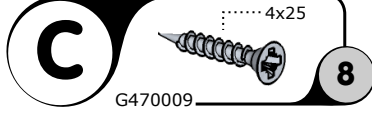
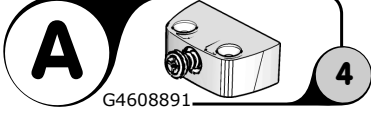
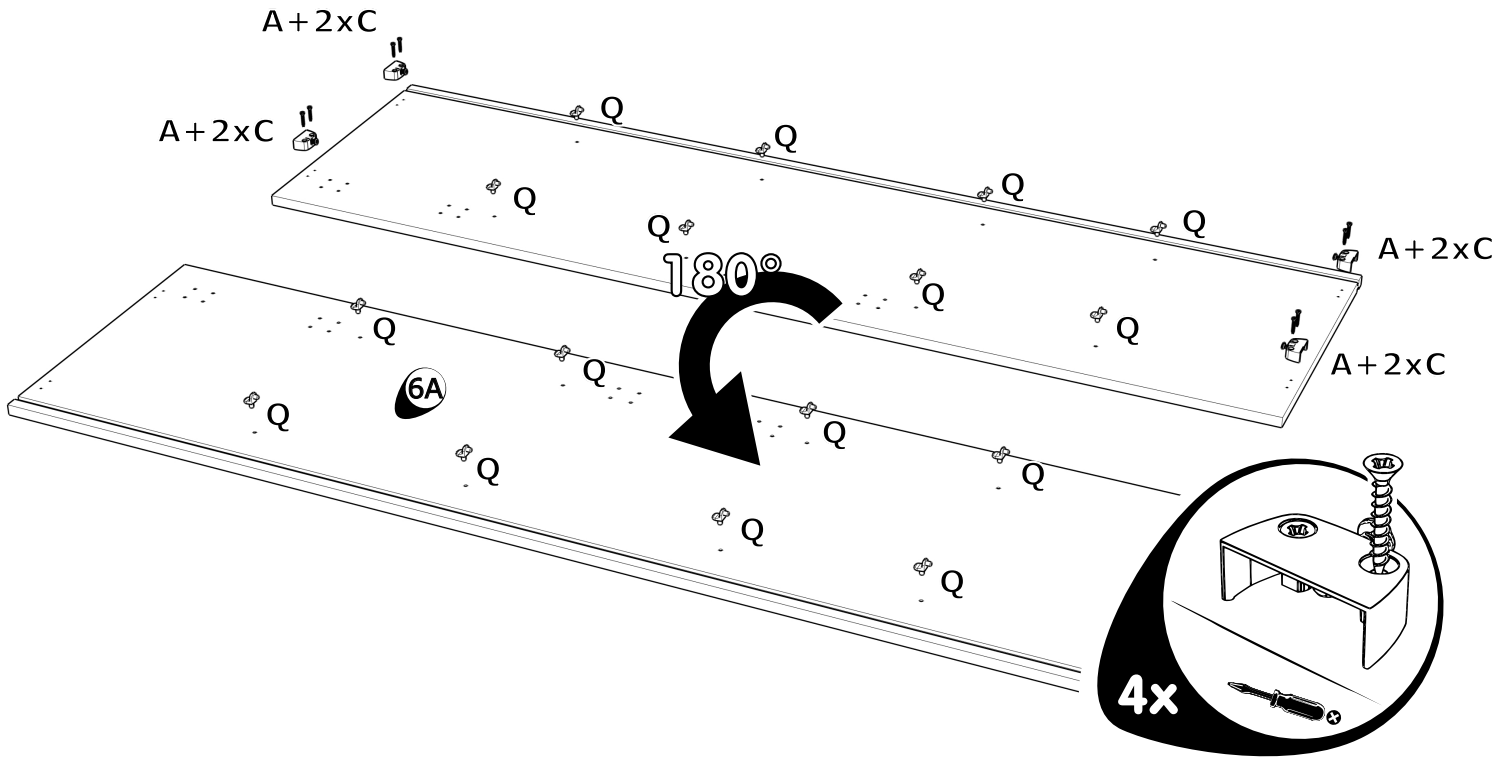

8

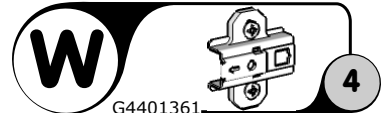
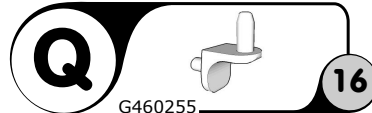
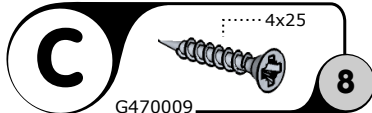
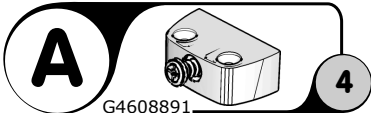
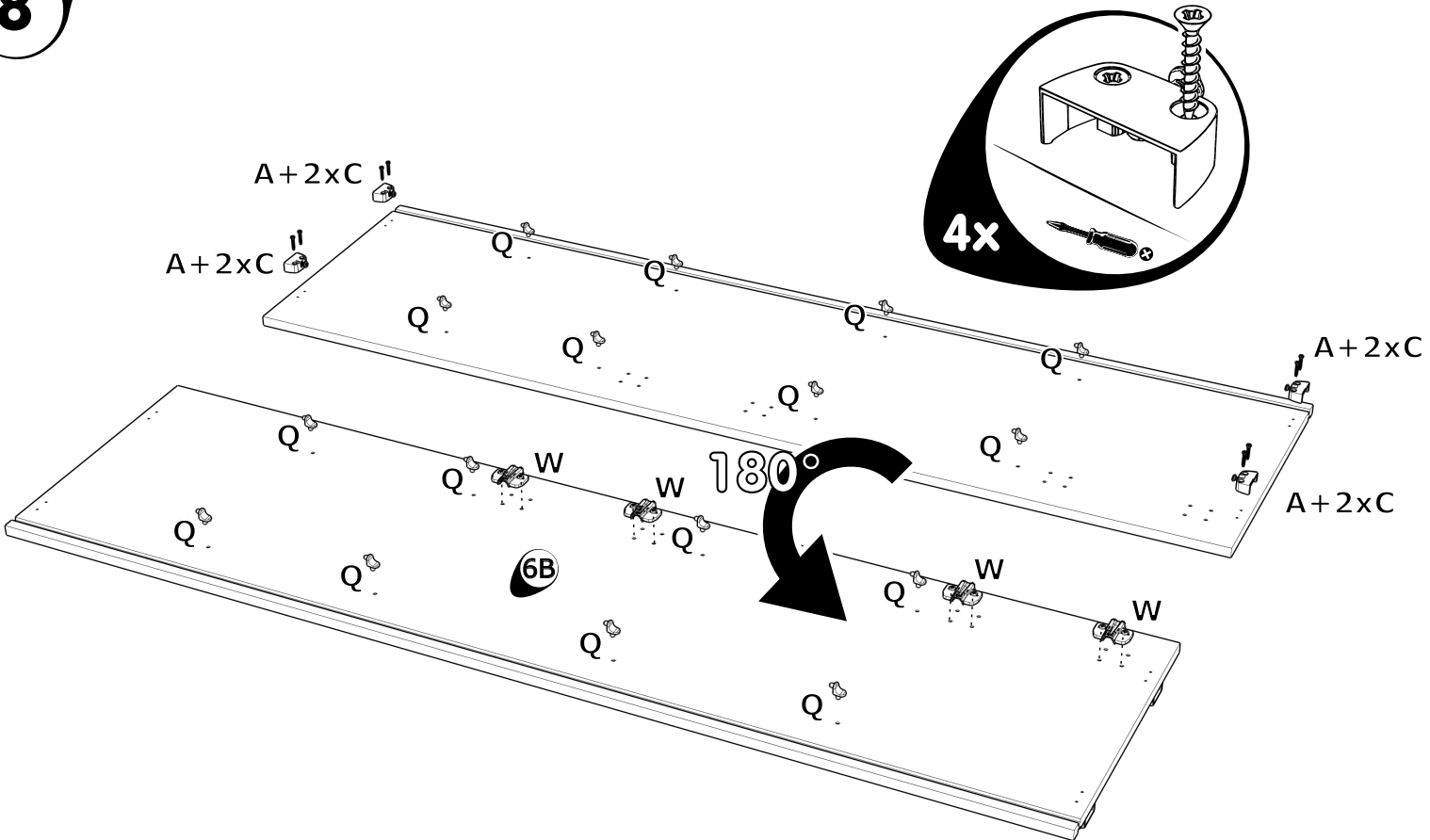

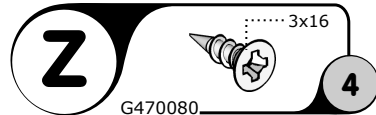
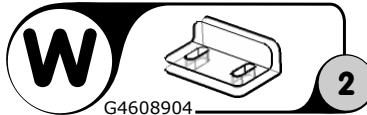
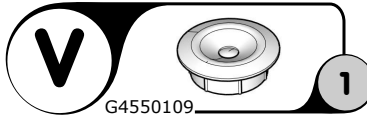
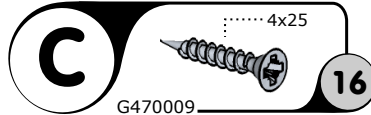
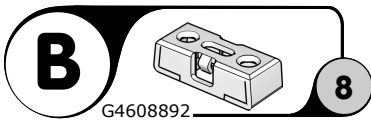
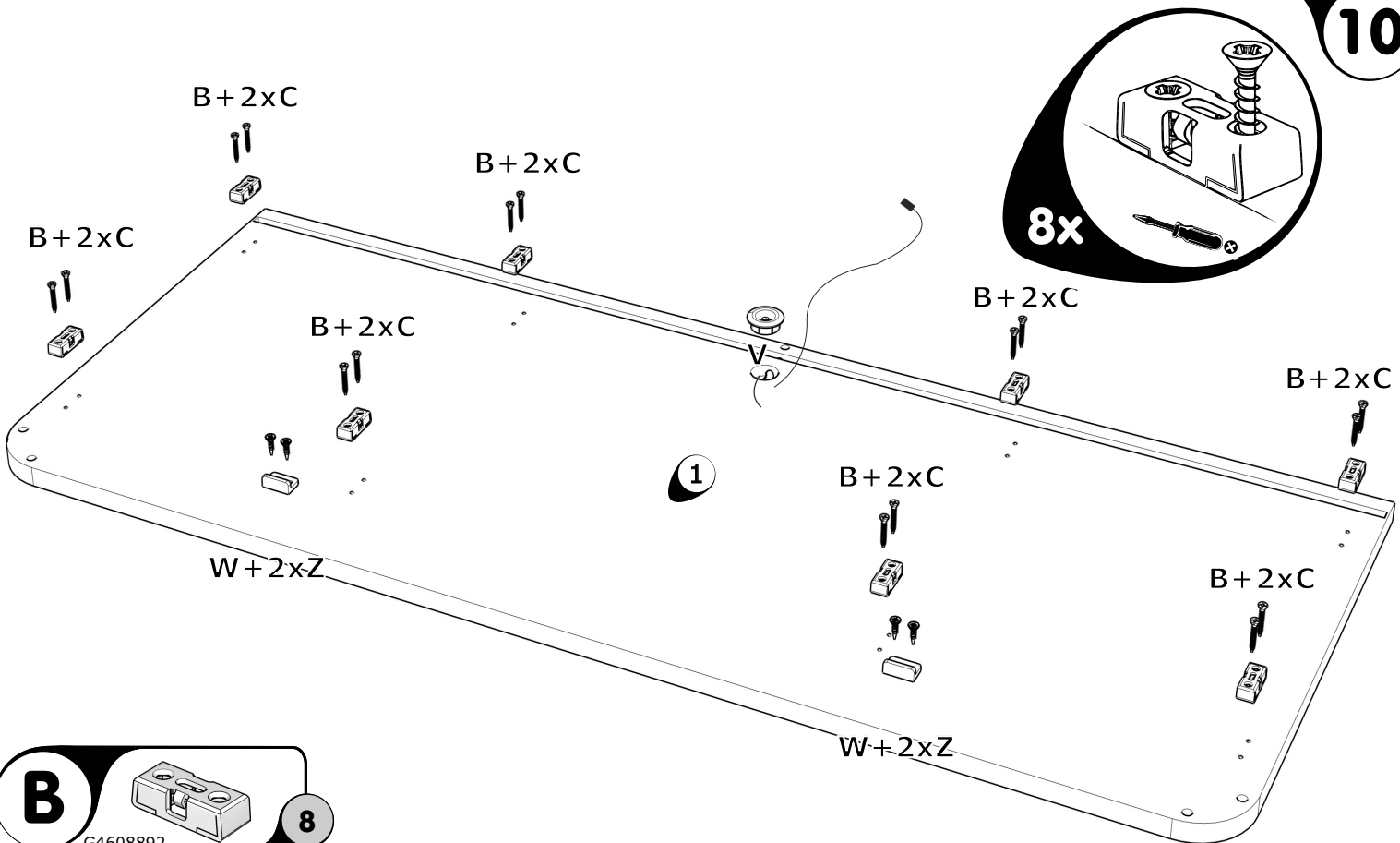
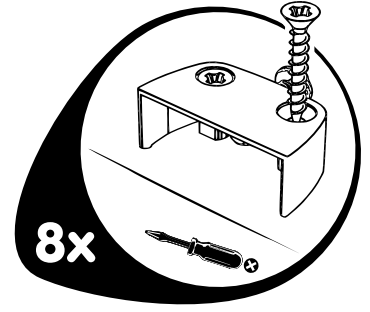
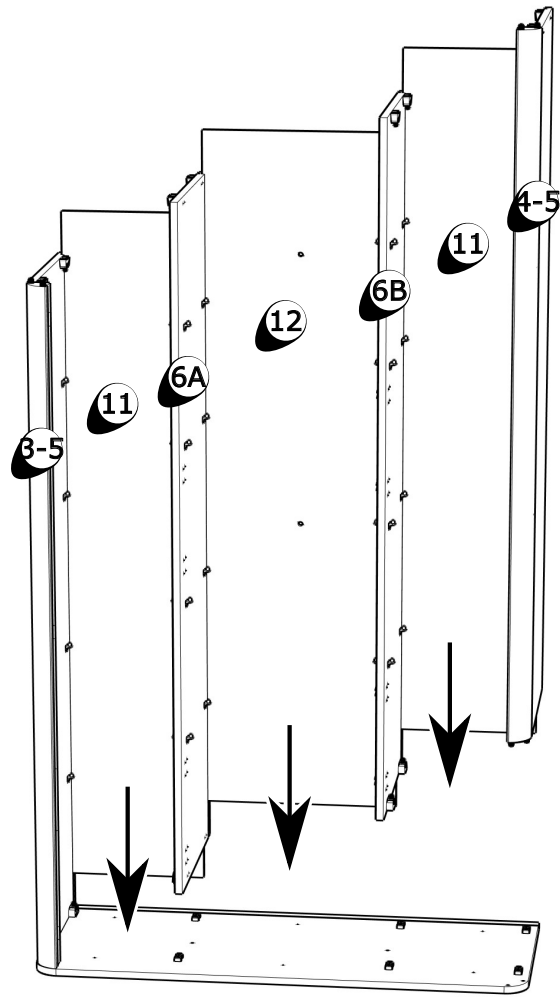

11

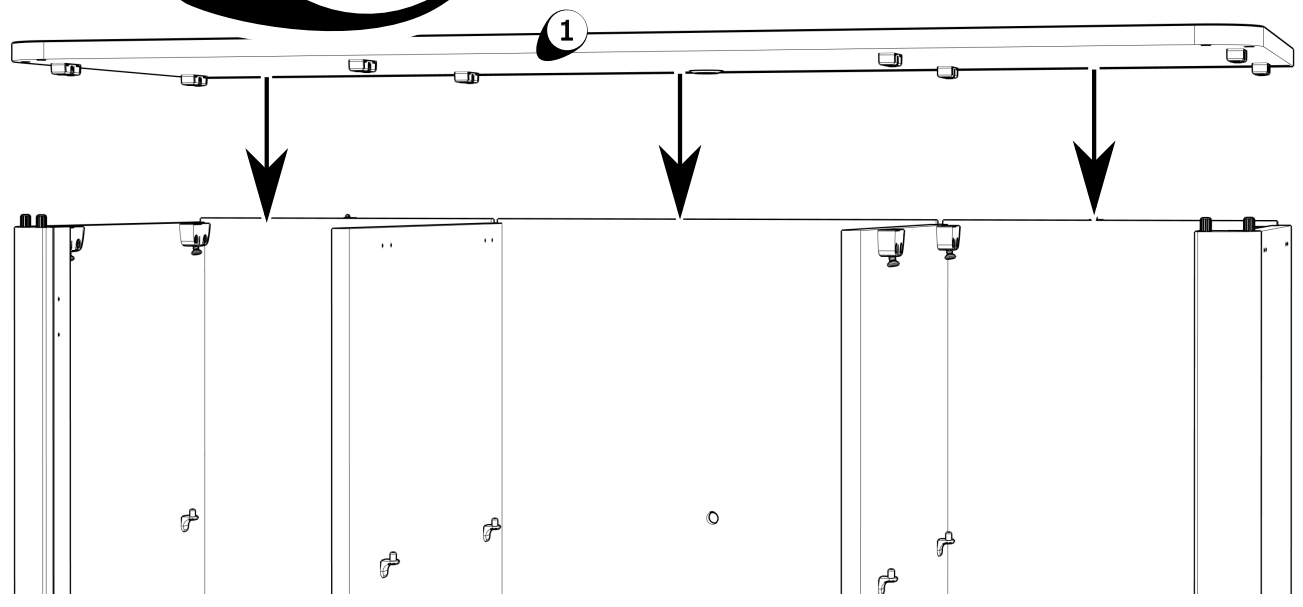
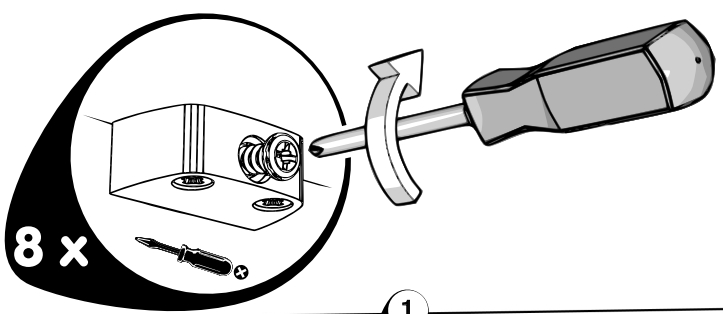

12

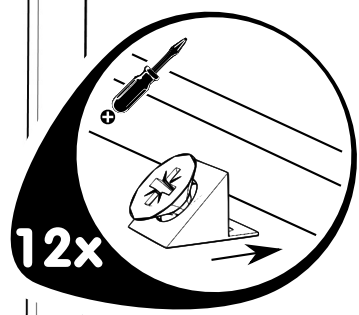
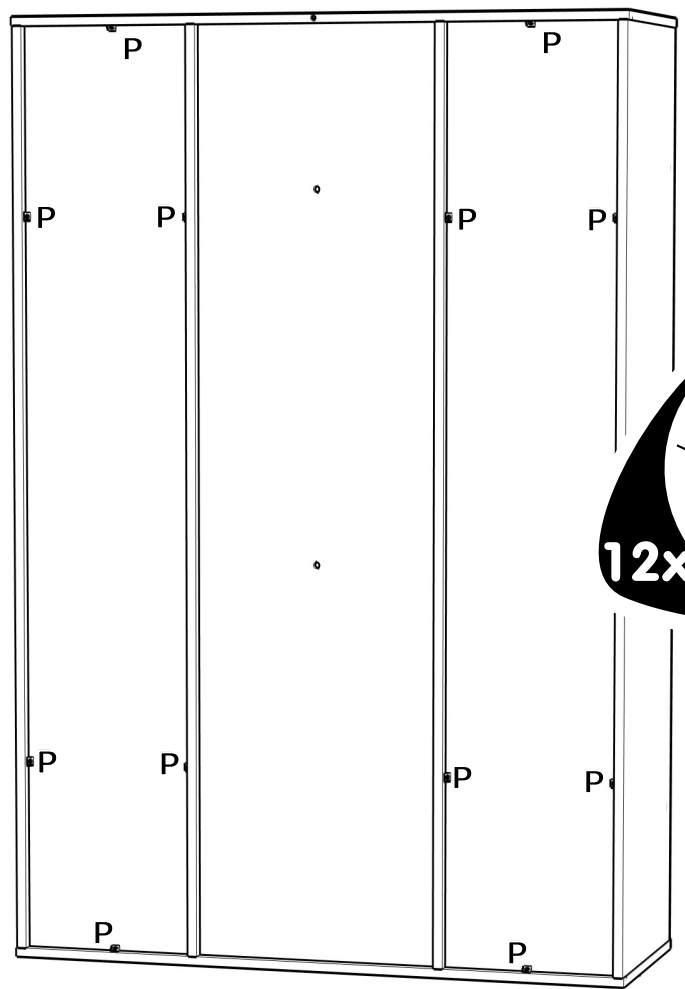

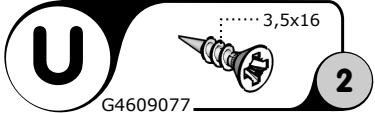
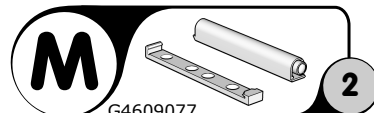
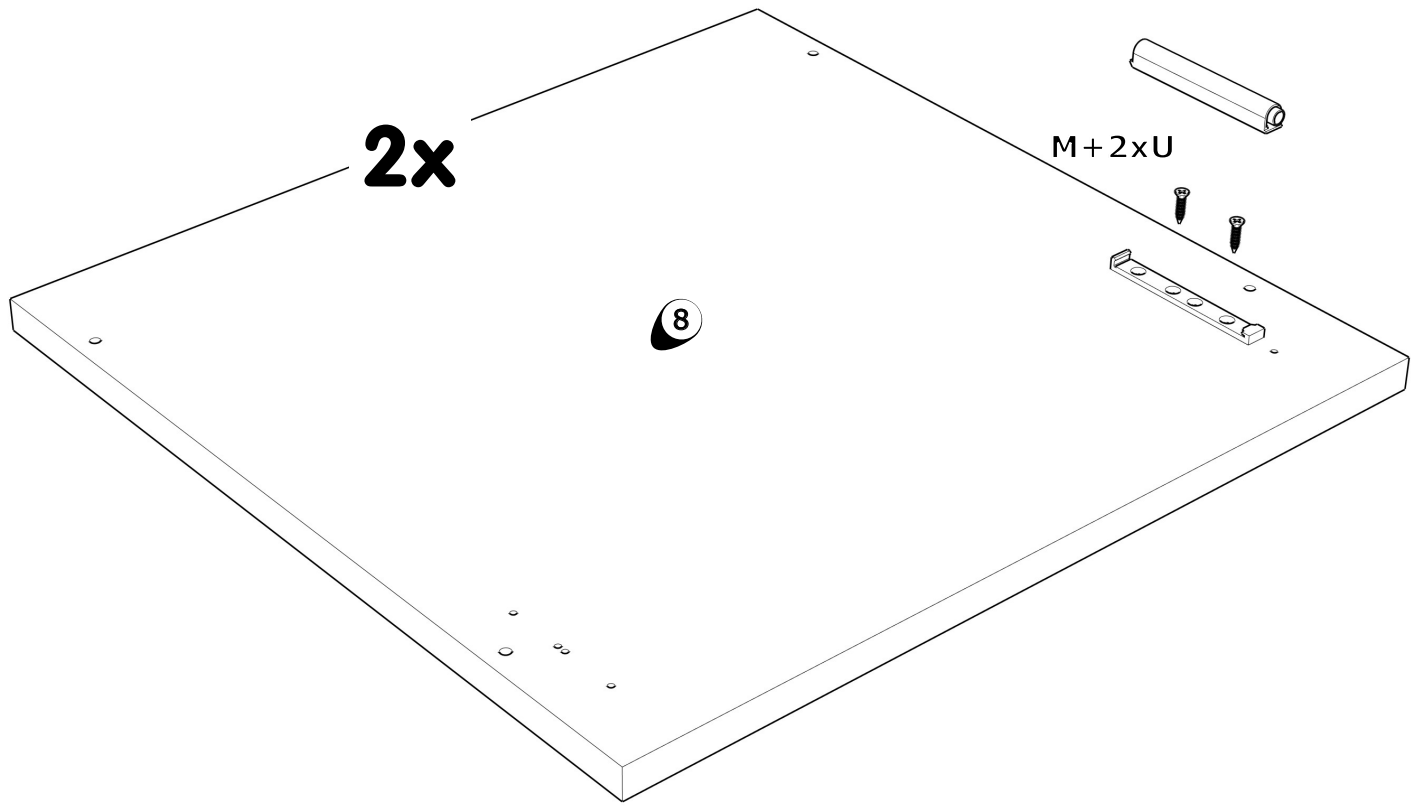
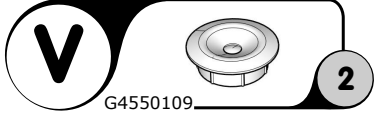
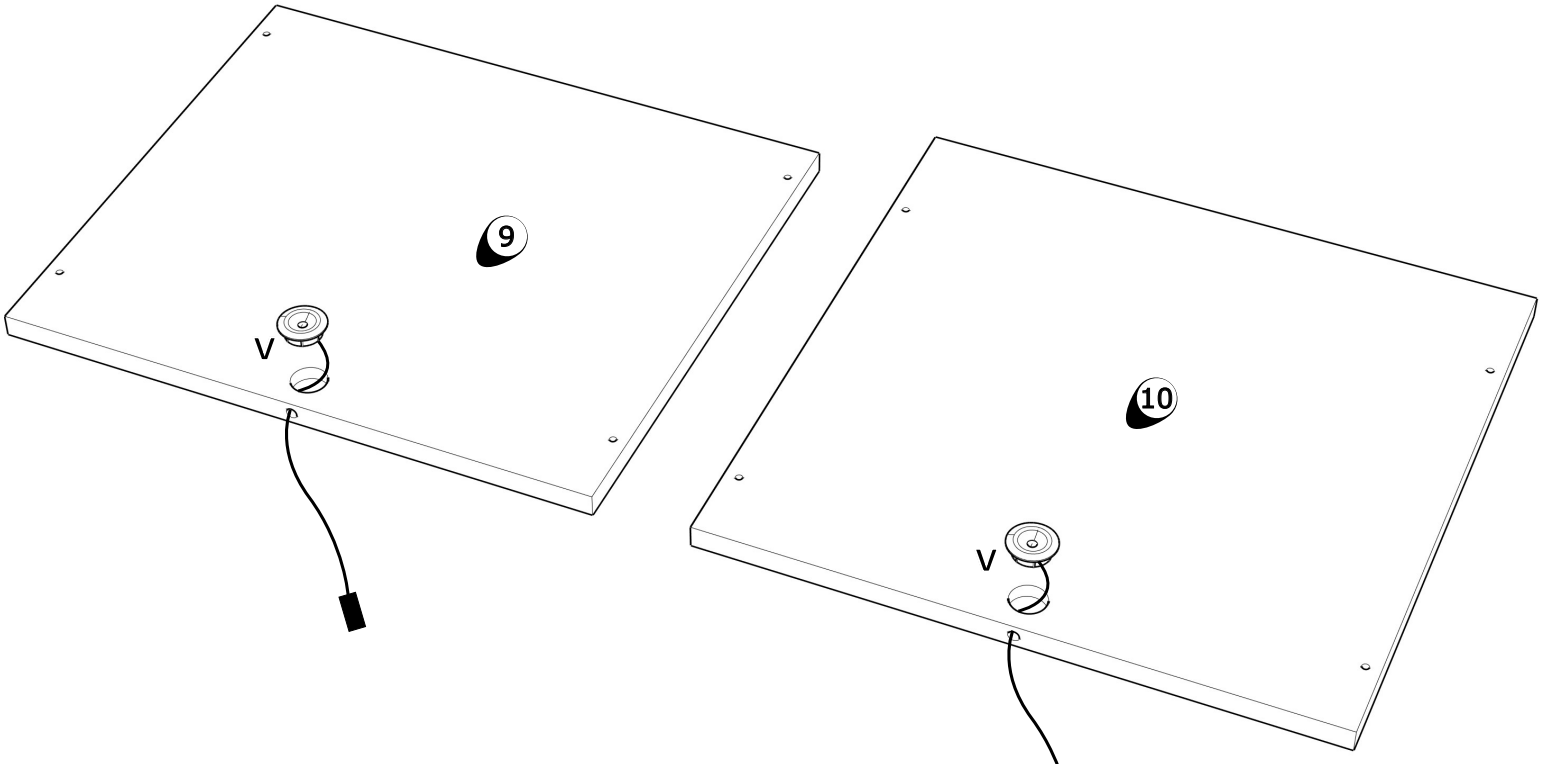

15

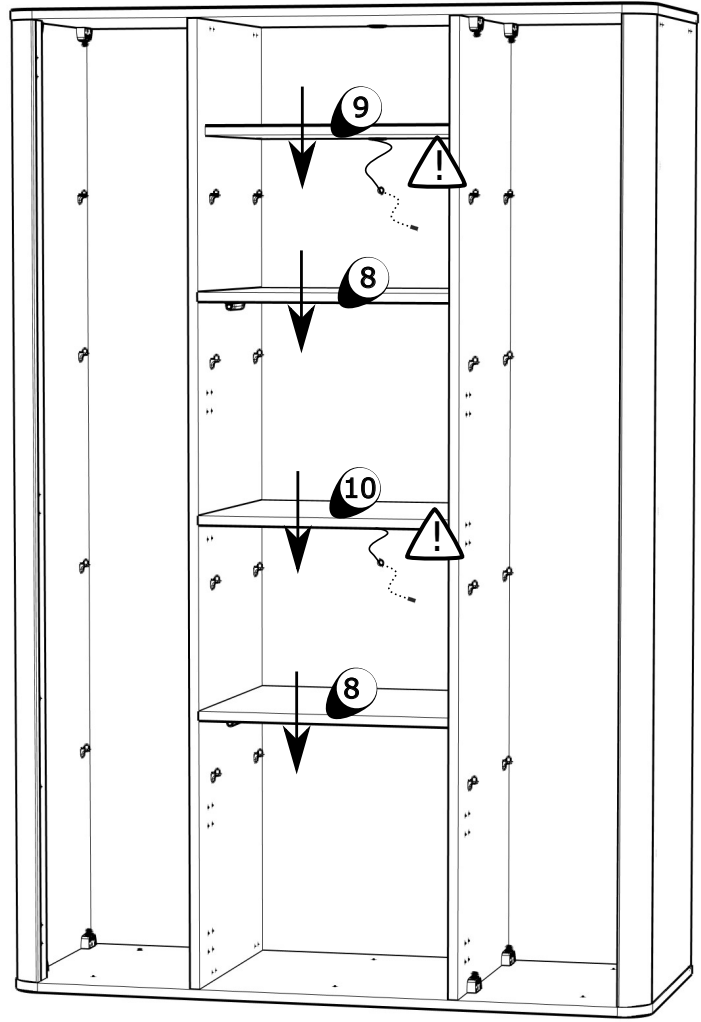

16

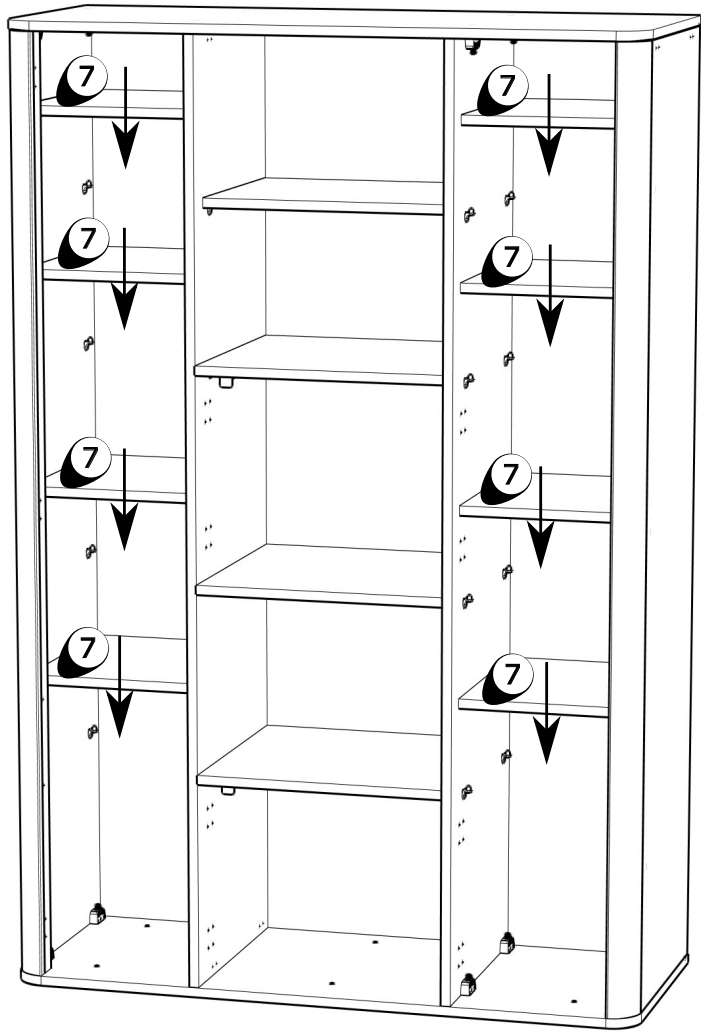

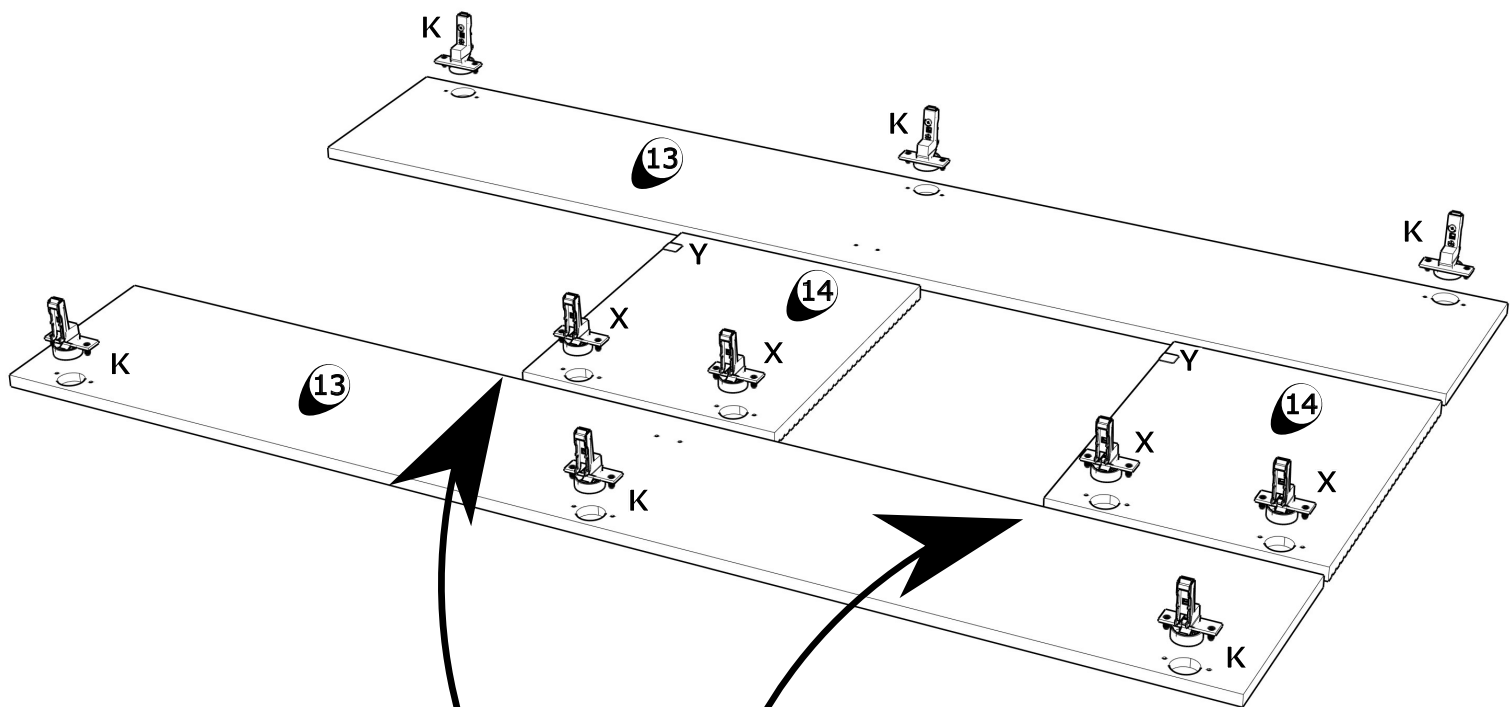
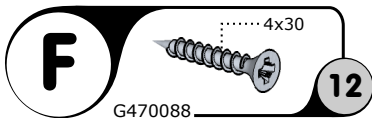
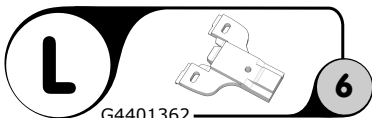
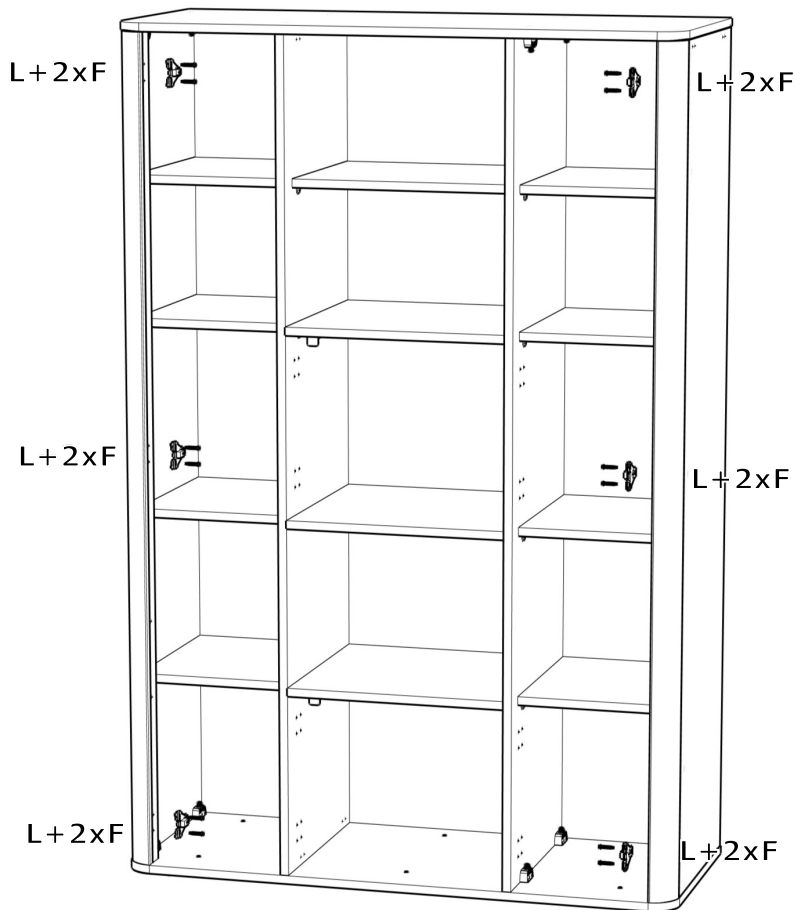

SOFTCLOSE

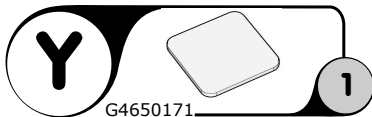
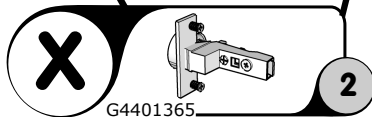
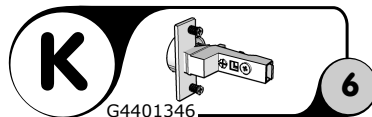

19

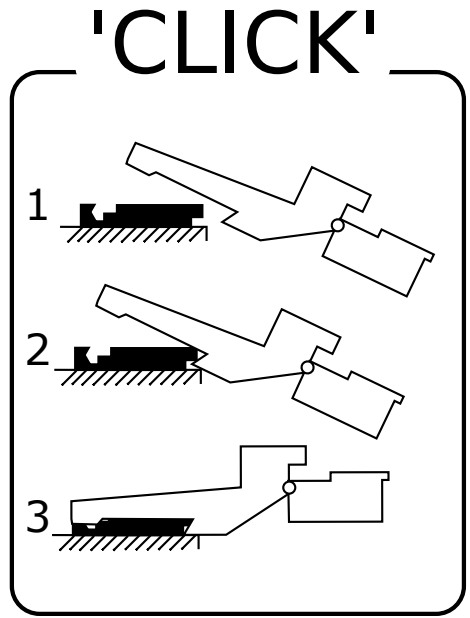
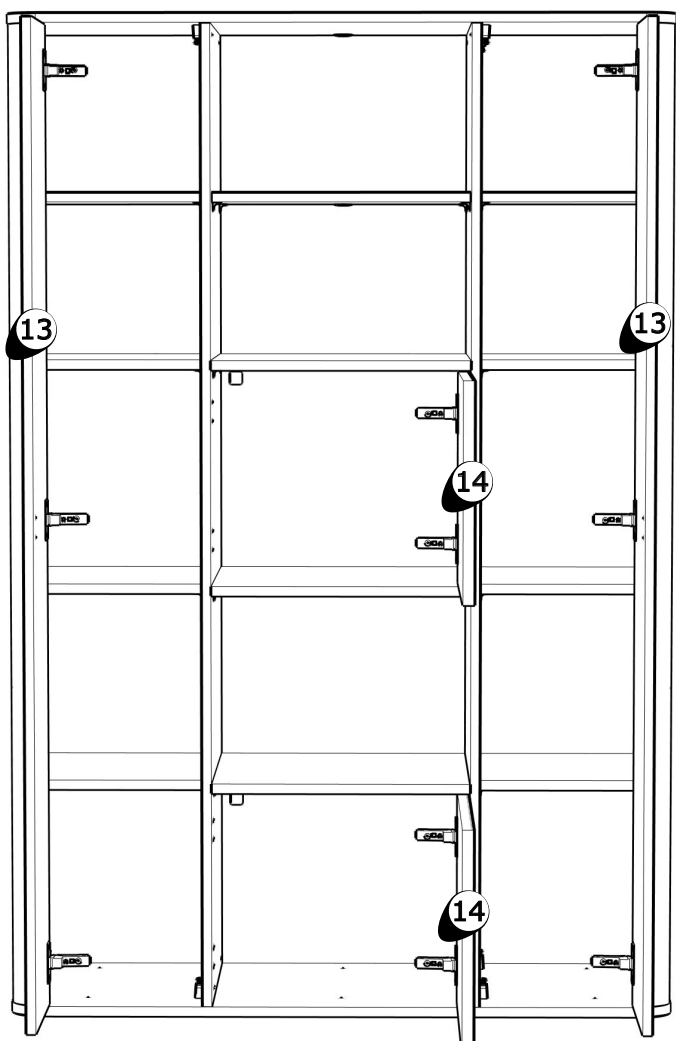

20

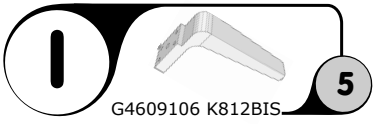
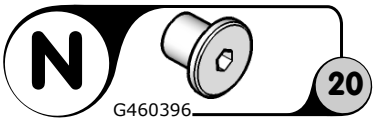
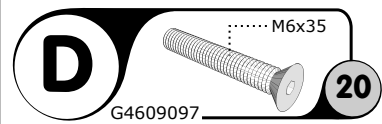
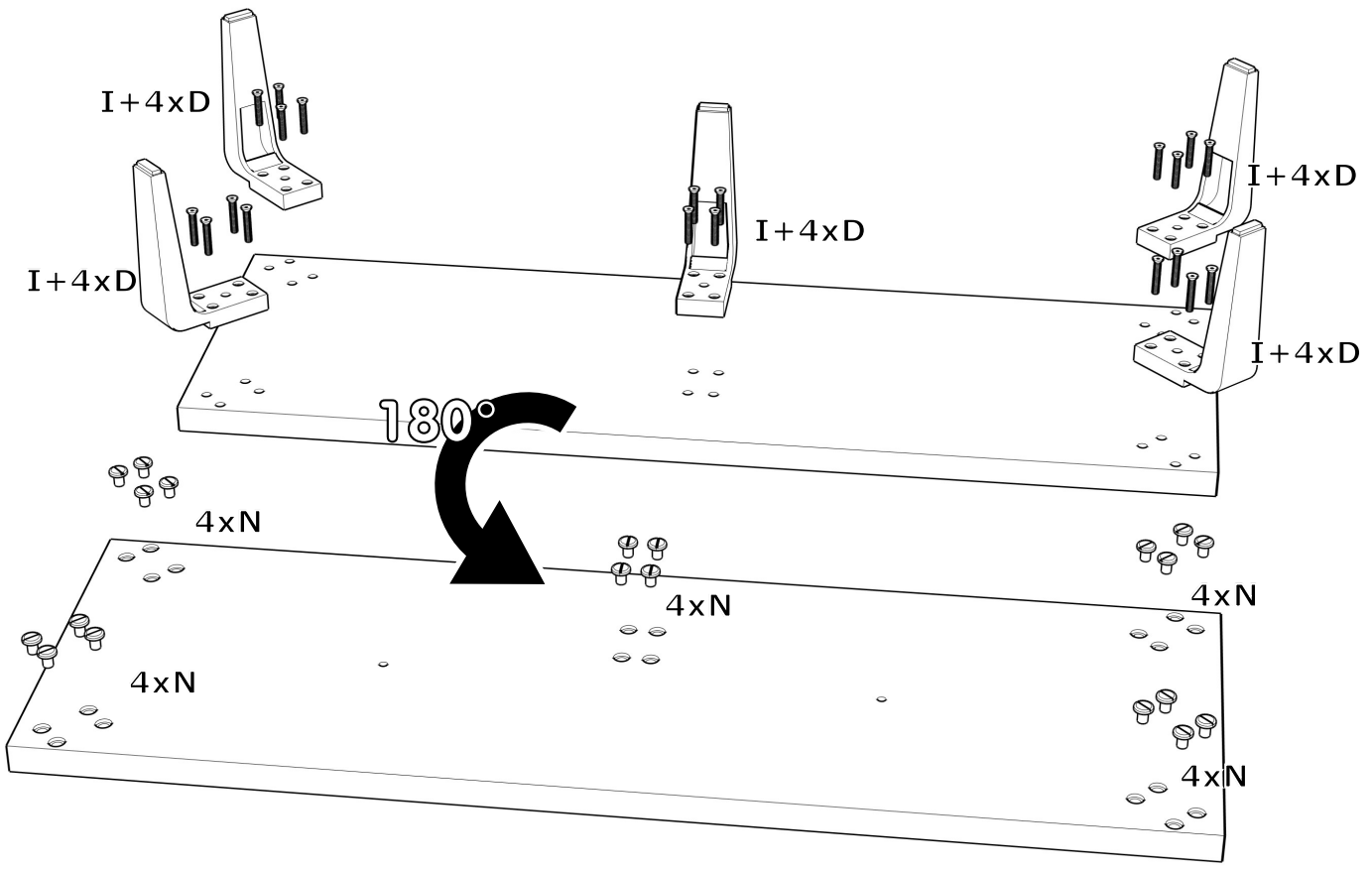

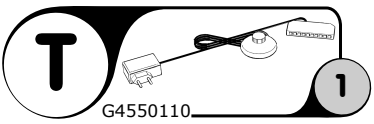
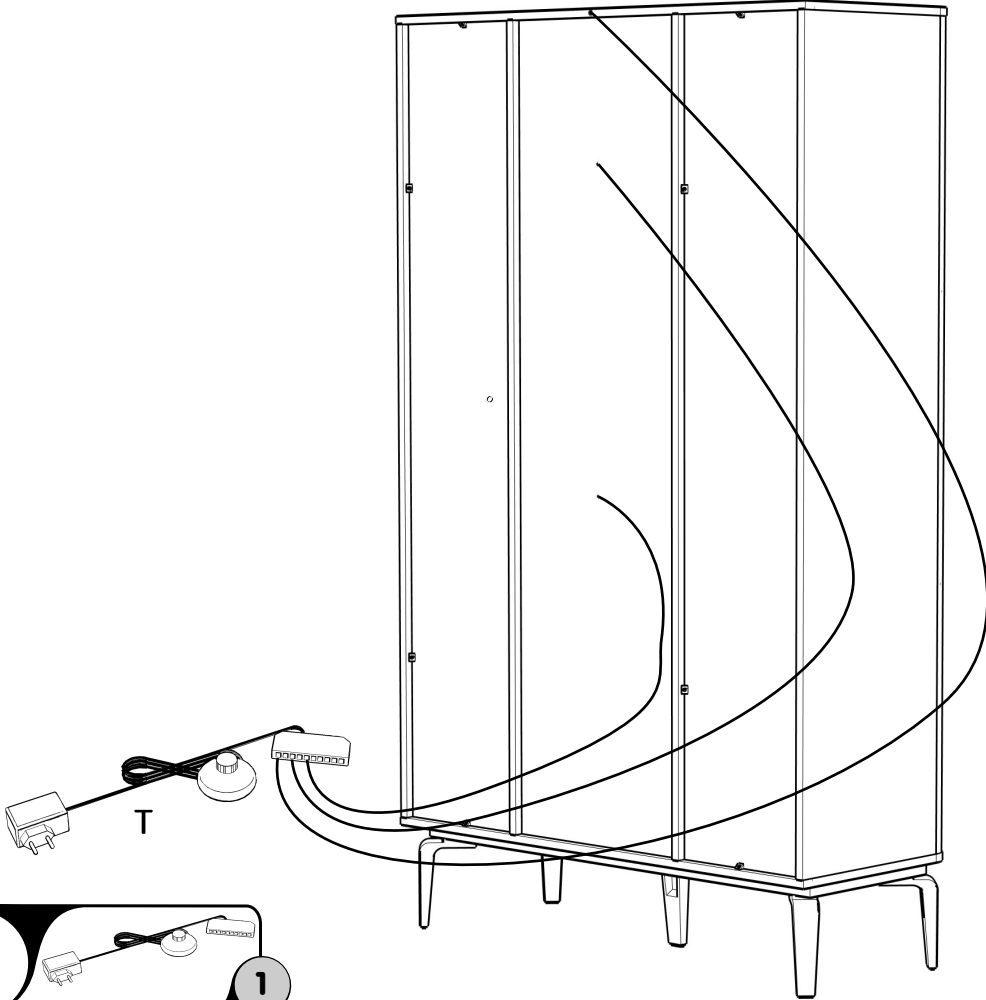
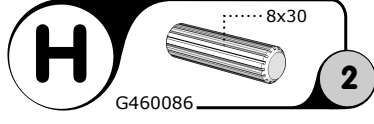
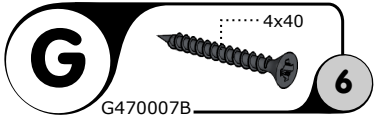
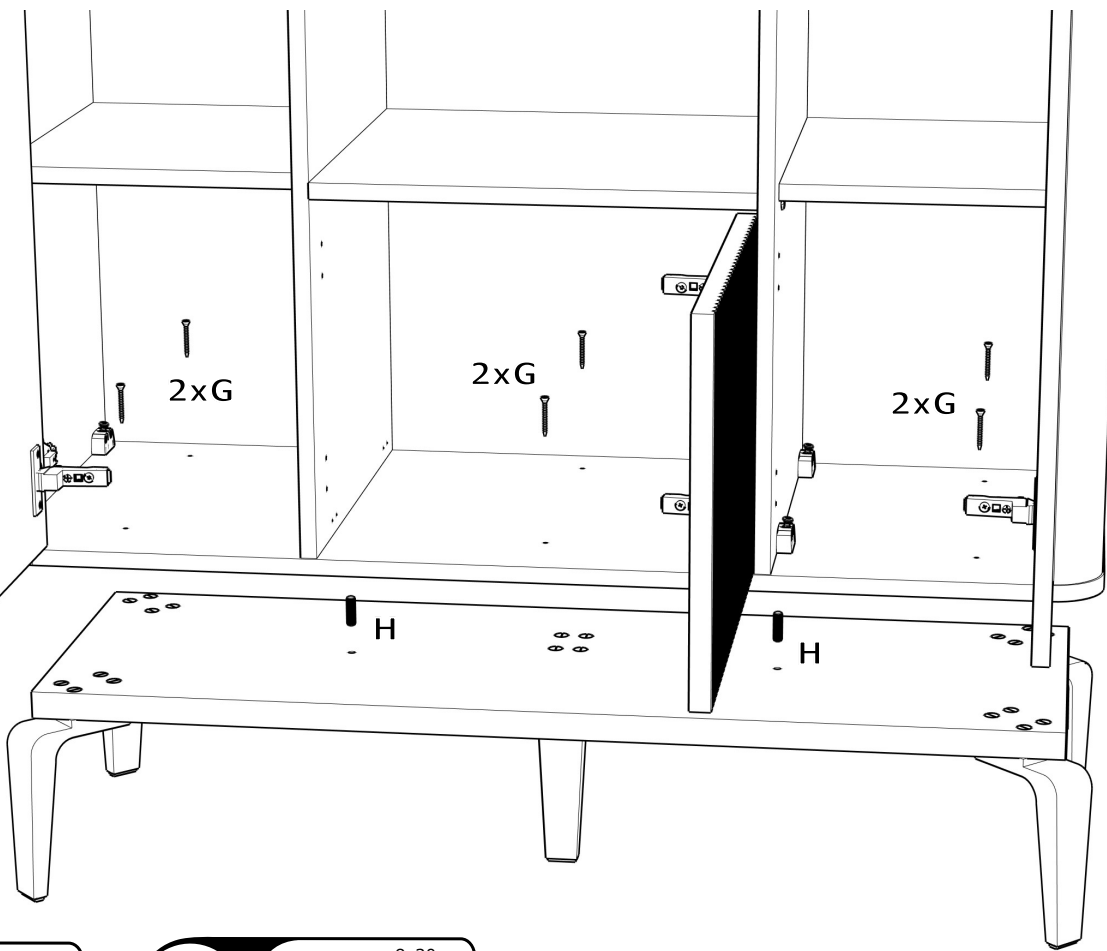

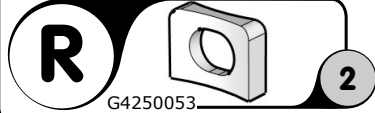
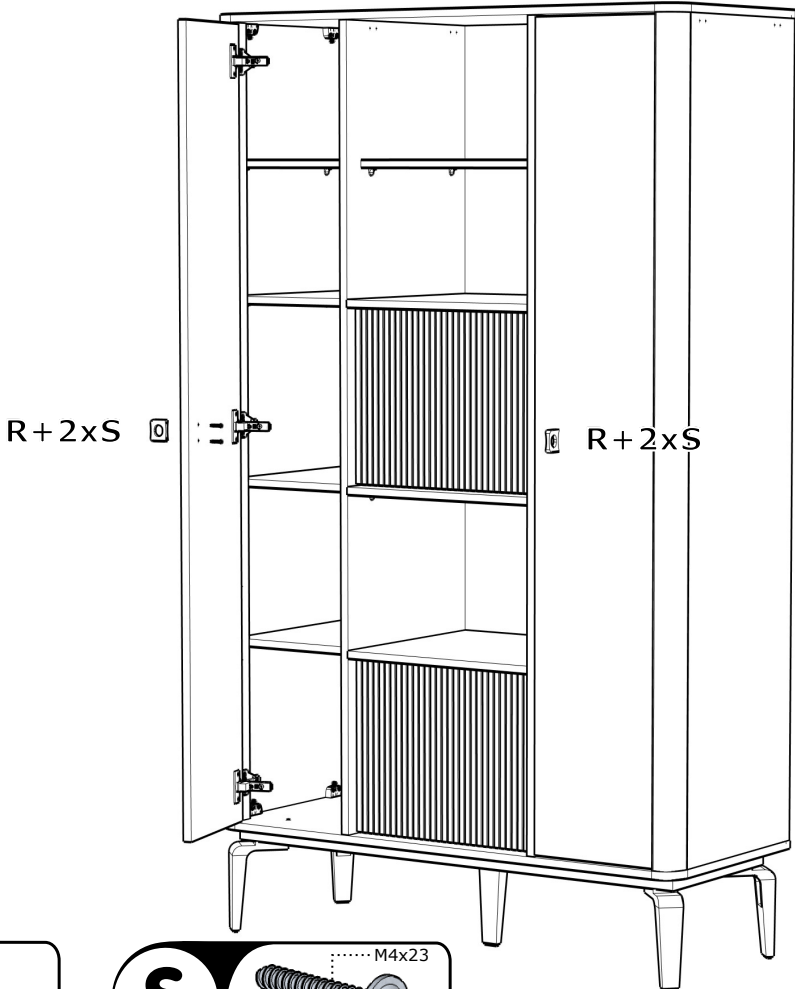

G4250053

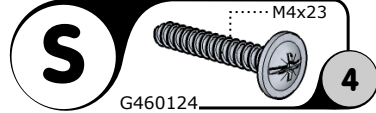

G460124



réglable - regelbaar - adjustable

'HINGE'

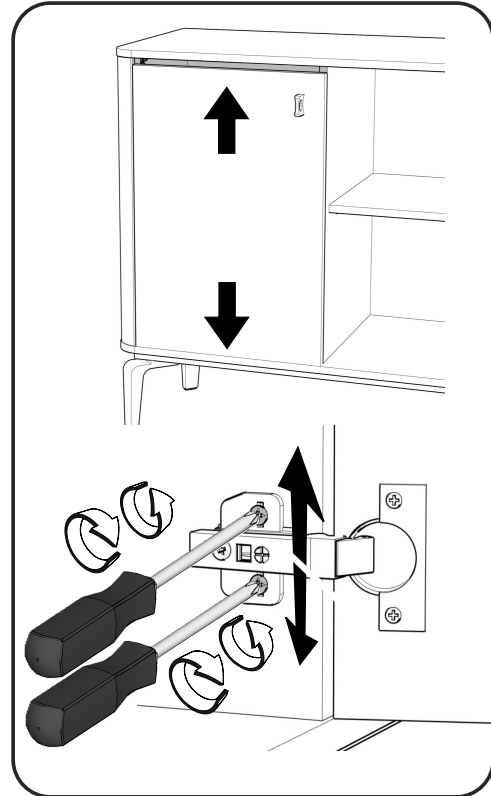
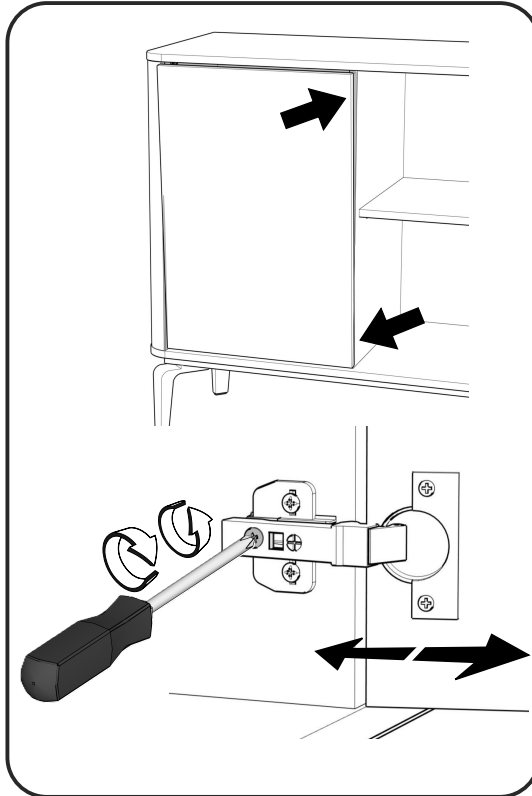
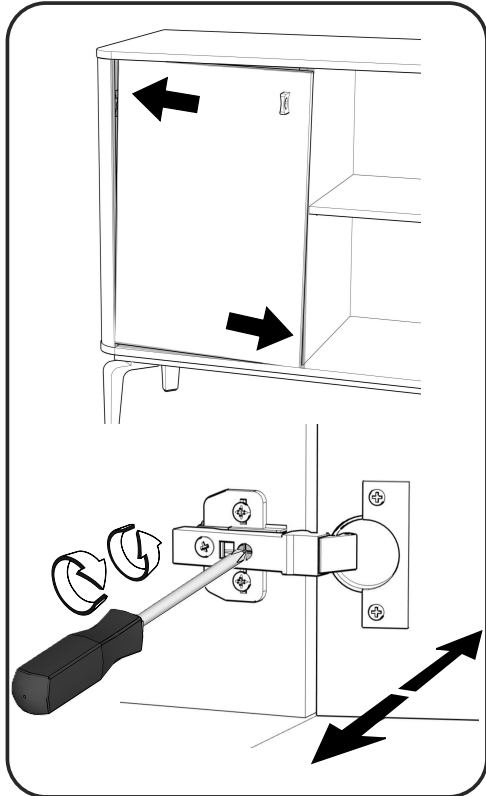

'PUSH-TO-OPEN'

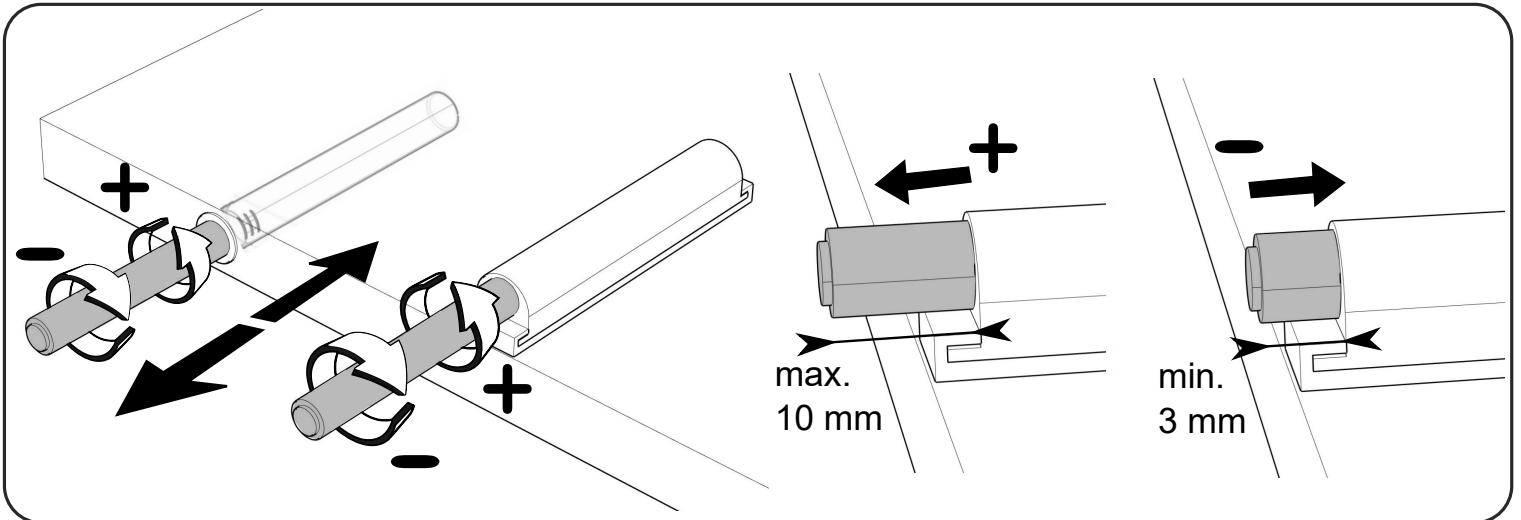

'DRAWER RUNNERS'

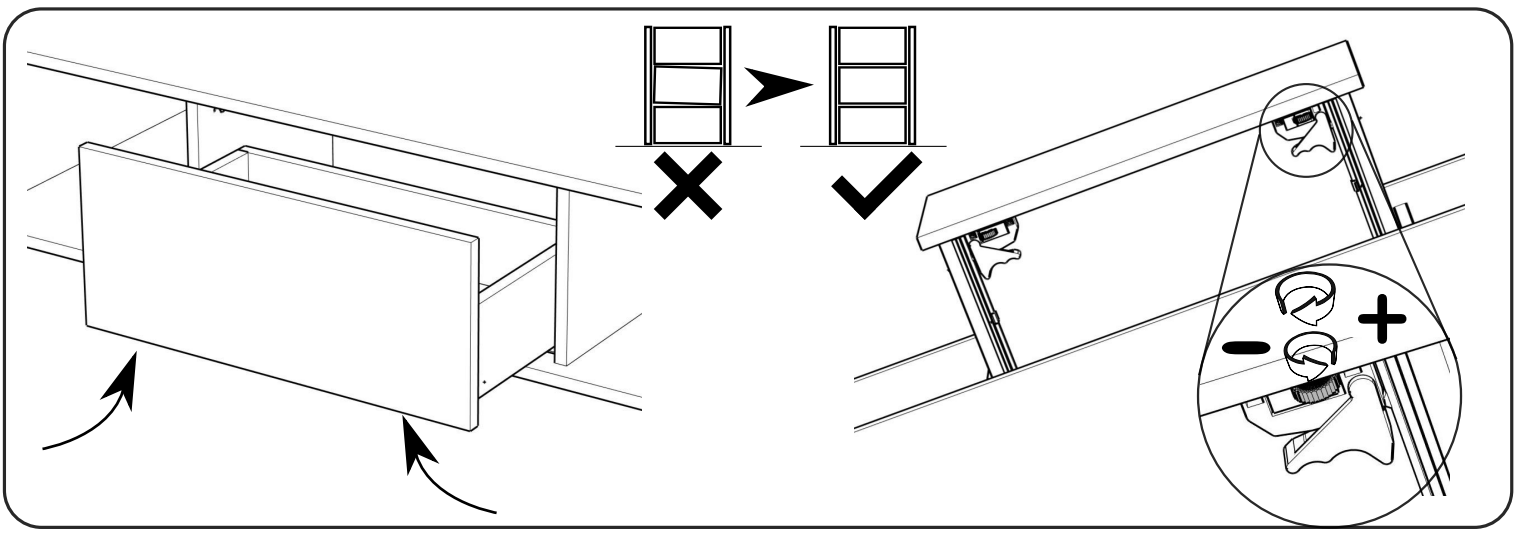

GEGEVENS AANKOPER

INFORMATIONS ACHETEUR - BUYER INFORMATION - KAUFER INFORMATIONEN

WINKEL

MAGASIN - SHOP - GESCHÄFT

PLAATS

LIEU - TOWN - ORT

ORDERBEVESTIGINGSNUMMER

N° DE CONFIRMATION DE LA COMMANDE - ORDER CONFIRMATION N°

KLEUR

COULEUR - COLOR - FARBE

AANKOOPDATUM

DATE DE L'ACHAT - DATE OF PURCHASE - KAUFDATUM

UW REFERENTIE

REFERENCE - REFERENCE - REFERENZ

FACTUURNUMMER

NUMÉRO DE FACTURE - INVOICE NUMBER - RECHNUNGSNUMMER

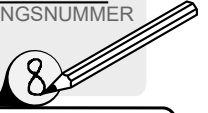

A G4608891 	B G4608892 	C G4700094x25 	D G4609097M6x35
E G460249 	F G4700884x30 	G G470007B4x40 	H G4600868x30
I G4609106 K812BIS 	J G4401345 	K G4401346 	L G4401362
M G4609077 	N G460396 	O G460252 	P G4608717
Q G460255 	R G4250053 	S G460124M4x23 	T G4550110
U G4700133,5x16 	V G4550109 	X G4401365 	Y G4650171
W G4608904 	Z G4700803x16 		

TOELICHTING EXPLICATIONS - EXPLANATION - ERKLÄRUNG

Blank area for providing explanations or instructions in multiple languages.

GEGEVENS AANKOPER

INFORMATIONS ACHETEUR - BUYER INFORMATION - KAUFER INFORMATIONEN

WINKEL

MAGASIN - SHOP - GESCHÄFT

PLAATS

LIEU - TOWN - ORT

ORDERBEVESTIGINGSNUMMER

N° DE CONFIRMATION DE LA COMMANDE - ORDER CONFIRMATION N°

KLEUR

COULEUR - COLOR - FARBE

AANKOOPDATUM

DATE DE L'ACHAT - DATE OF PURCHASE - KAUFDATUM

UW REFERENTIE

REFERENCE - REFERENCE - REFERENZ

FACTUURNUMMER

NUMÉRO DE FACTURE - INVOICE NUMBER - RECHNUNGSNUMMER

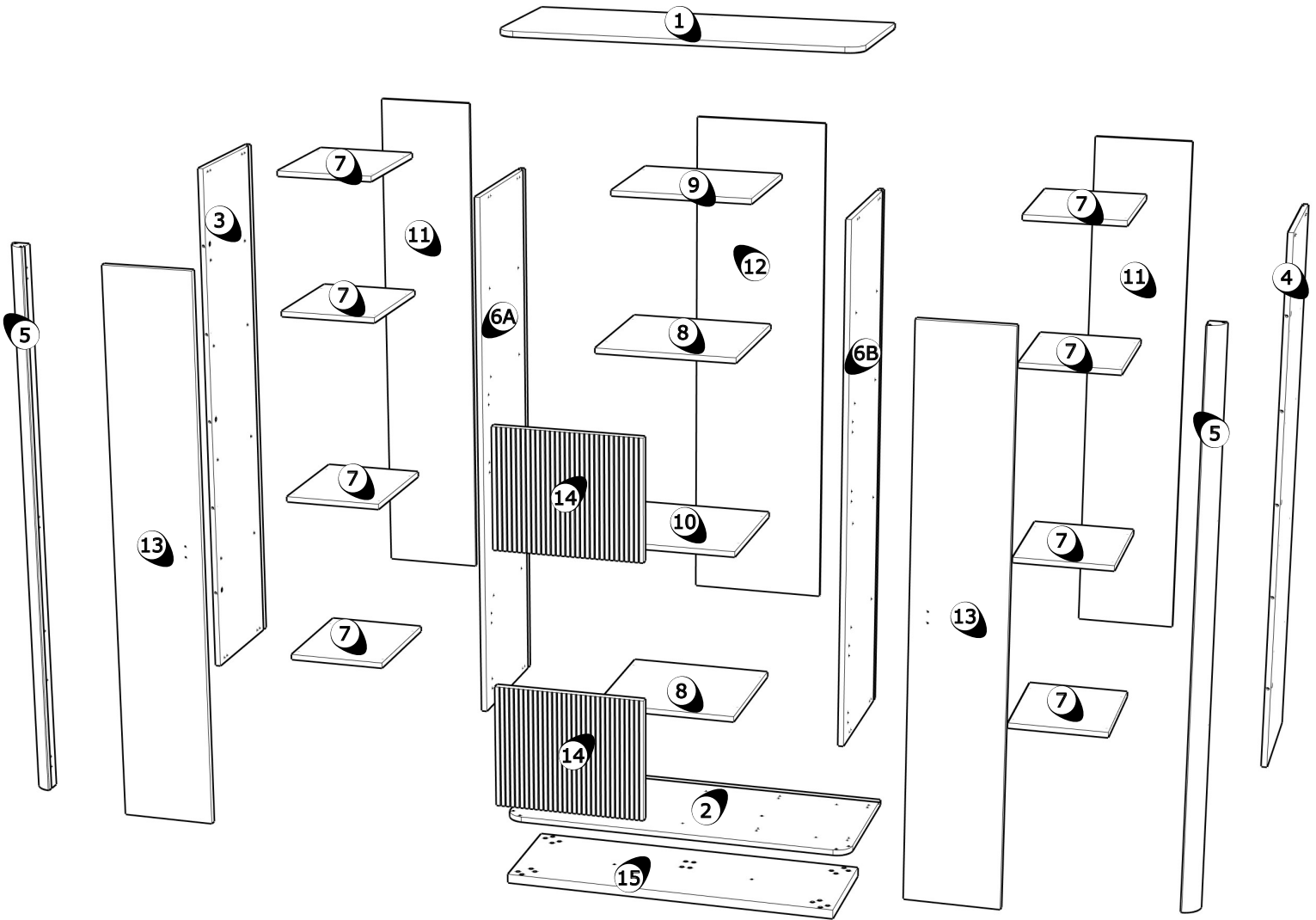

1 T6242007
1115 x 451 x 16

2 T6242013
1115 x 451 x 16

3 T6242021
1650 x 400 x 16

4 T6242022
1650 x 400 x 49

5 G4807962
1650 x 49 x 49

6 T6242029
1650 x 448 x 16

7 T6242051
306 x 374 x 16

8 T6242052
435 x 423 x 16

9 T6242054
435 x 374 x 16

10 T6242053
435x 423 x 16

11 T6242064
1659 x 315 x 8

12 T6242065
1659 x 444 x 8

13 T6242040
1642 x 269 x 16

14 G4850176
354 x 431 x 19

15 T6242018
1053 x 350 x 28

TOELICHTING EXPLICATIONS - EXPLANATION - ERKLÄRUNG