

# ASSEMBLY INSTRUCTION

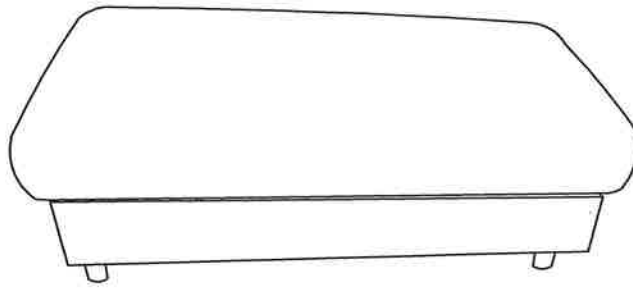

## PARTS LIST



A\*2



B\*2

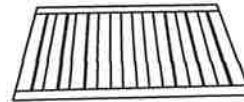

C\*1

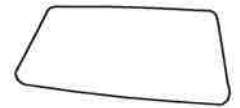

D\*1

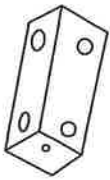

E\*4



F\*16



G\*16

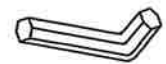

H\*1



I\*1



J\*4

# STEP 1

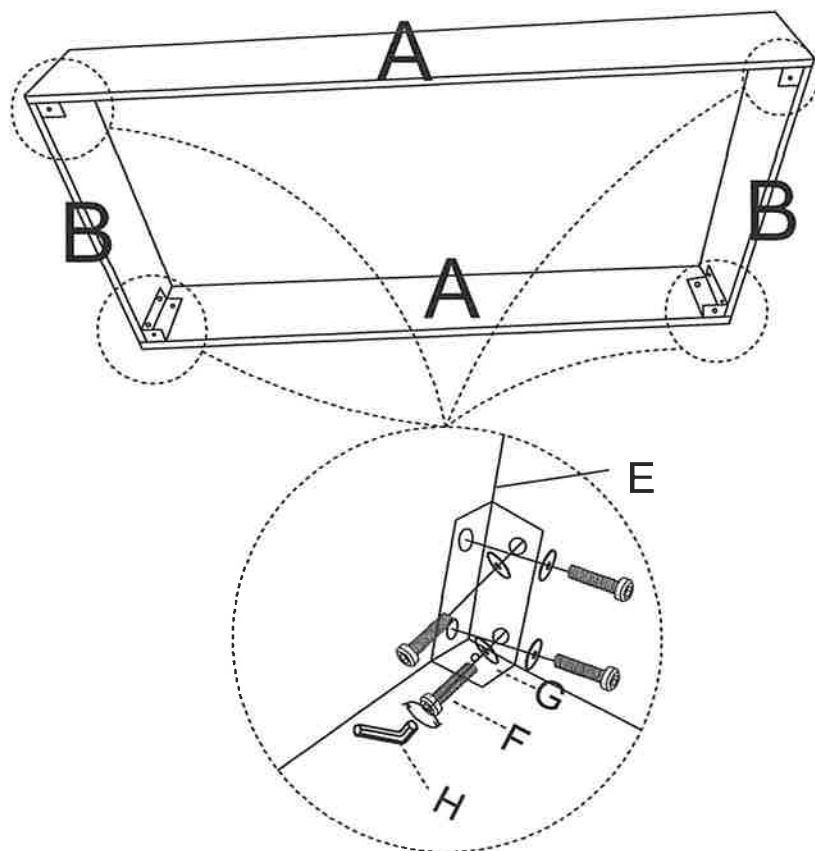

# STEP 2

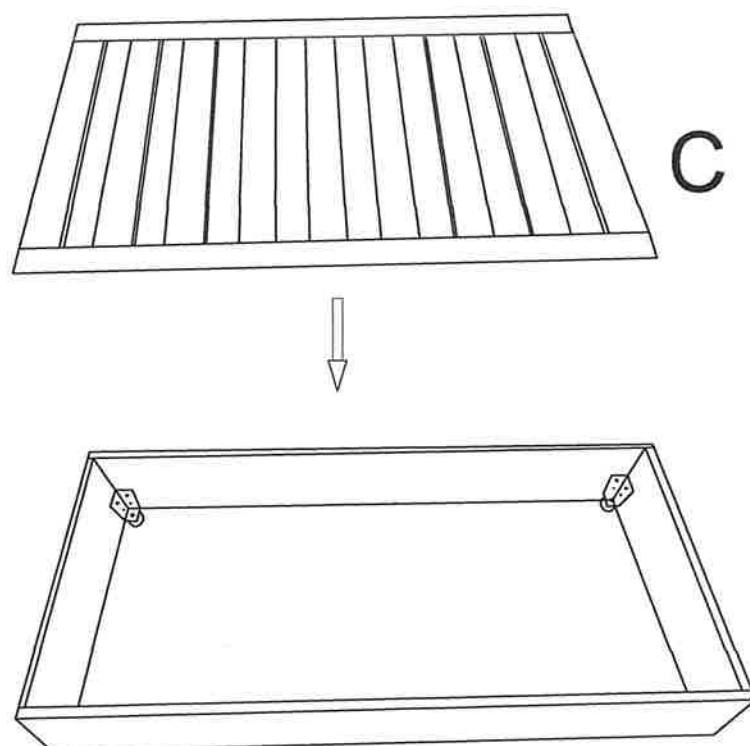

**STEP 3**

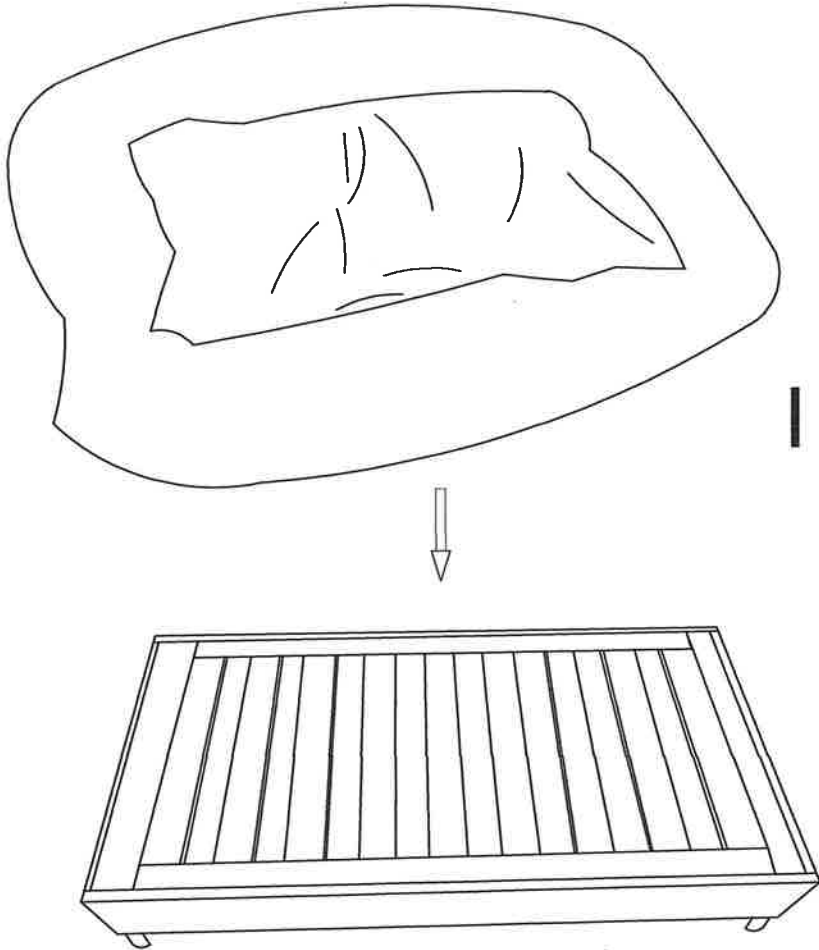

**STEP 4**

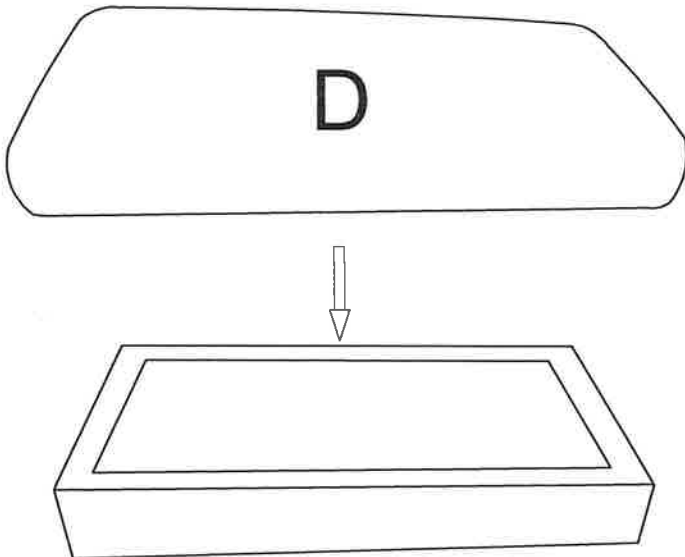

**STEP 5**

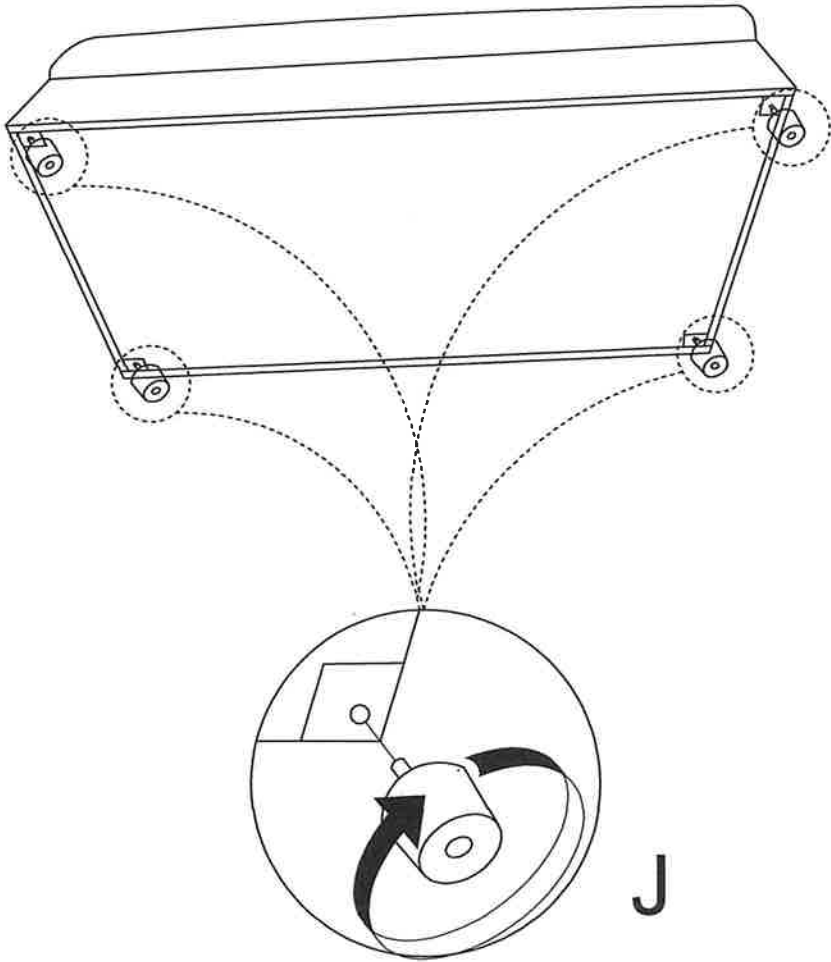

**STEP 6**

