

# ASSEMBLY INSTRUCTION

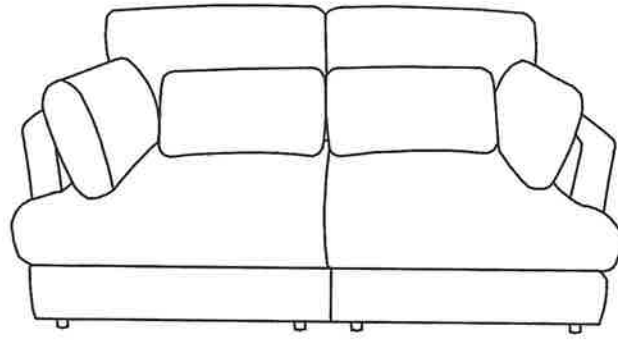

## PARTS LIST

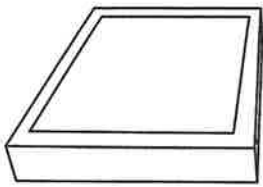

A\*1

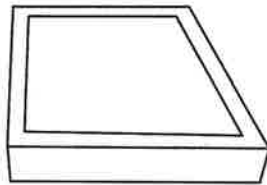

B\*1

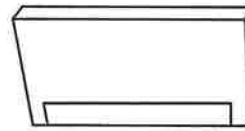

C\*1

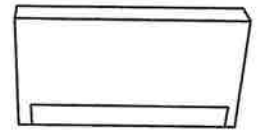

D\*1

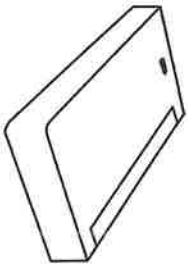

E\*1

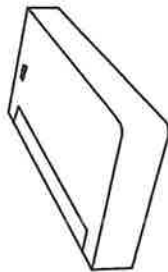

F\*1

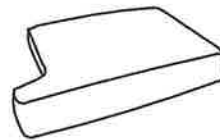

G\*1

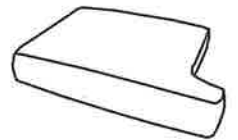

H\*1



I\*4

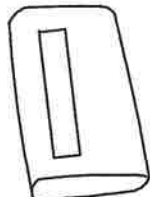

J\*2



N\*1



O\*8



P\*8



Q\*8

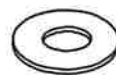

M\*8

STEP 1

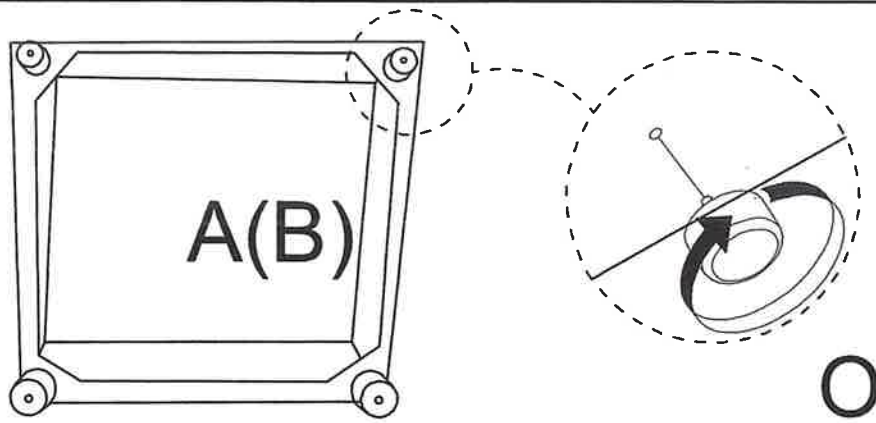

STEP 2

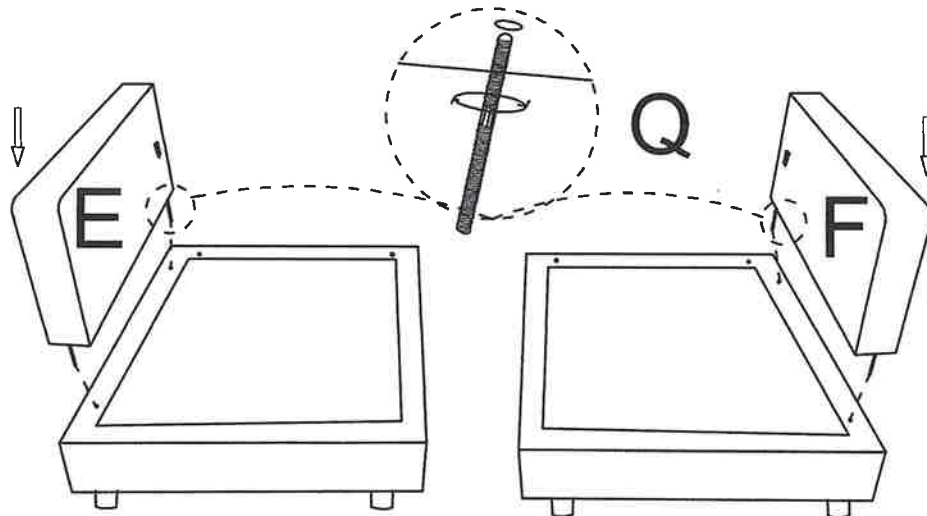

STEP 3

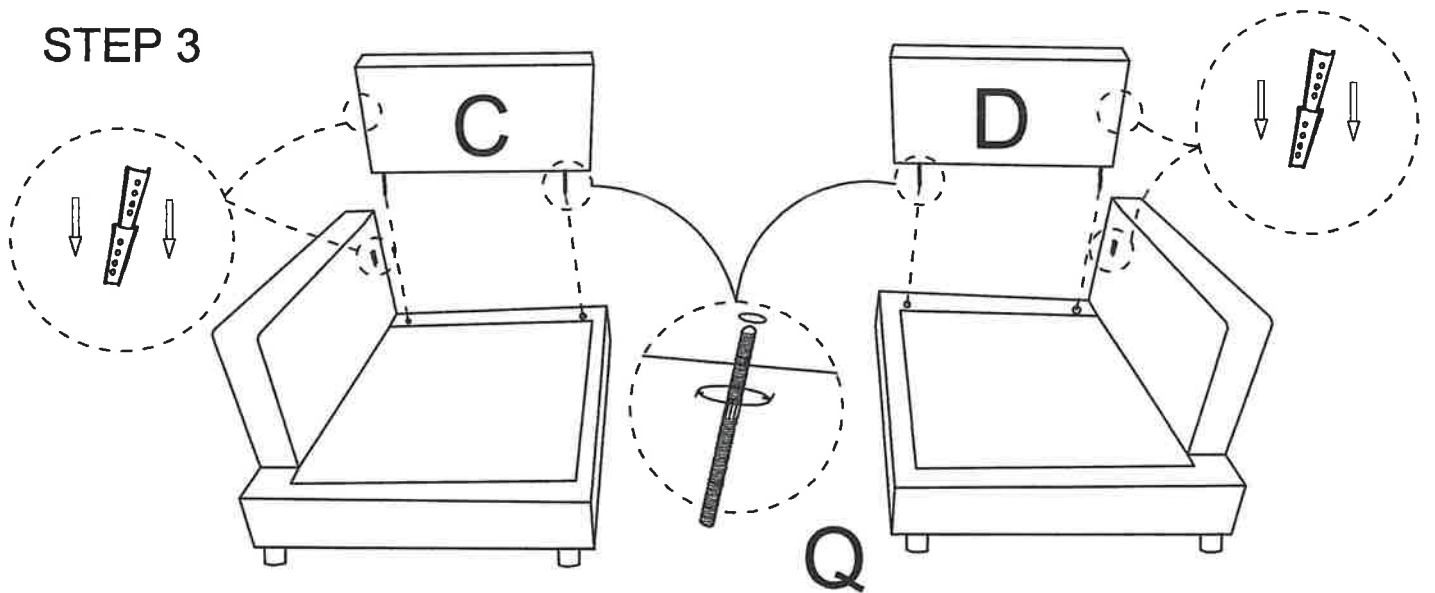

STEP 4

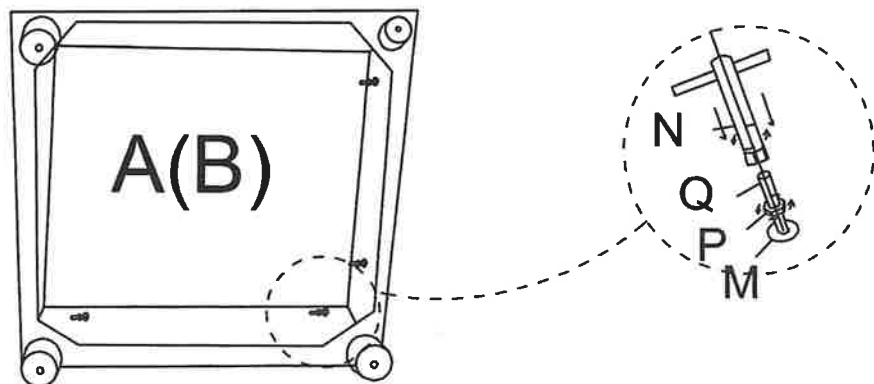

STEP 5

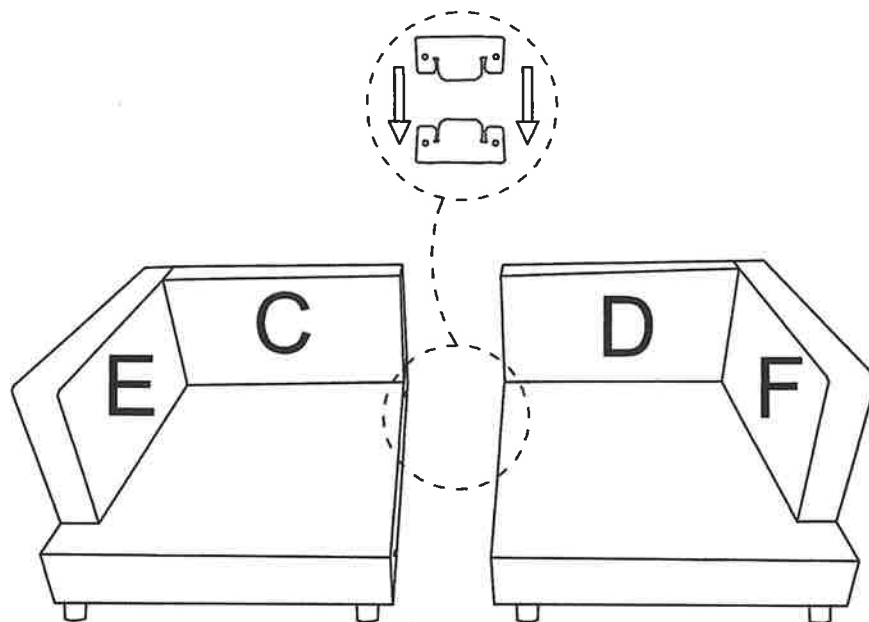

STEP 6

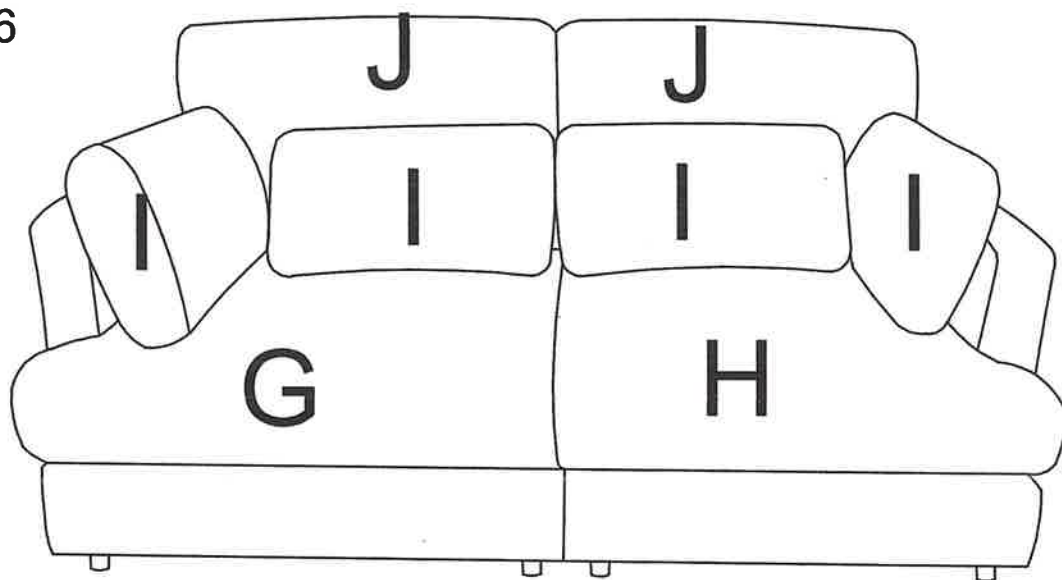

STEP 7

