

TV Kast  
Meuble TV  
TV Cabinet

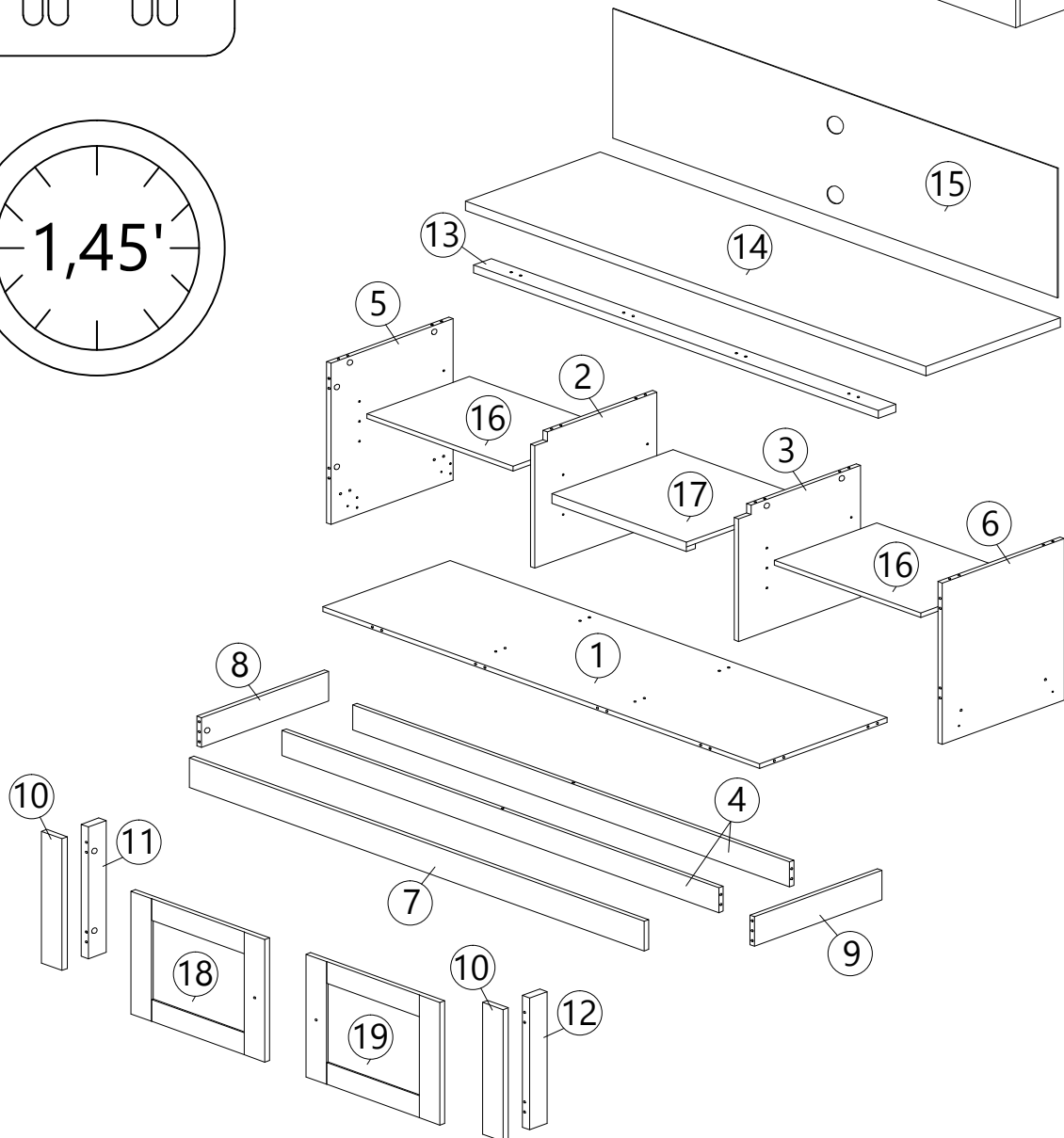

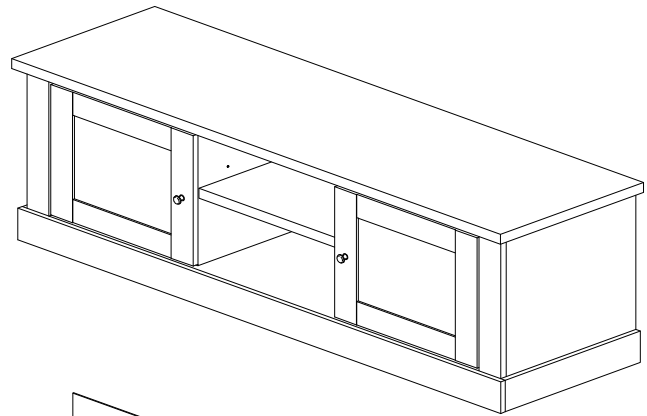
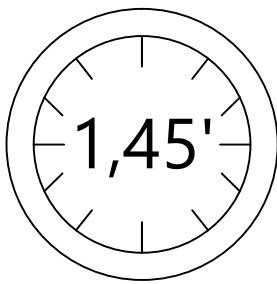
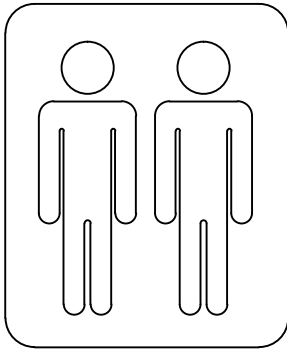
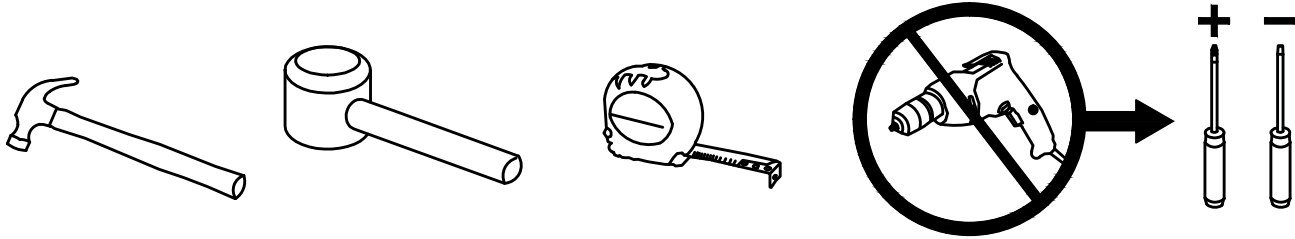

**ALGEMENE ONDERHOUDSVOORSCHRIFTEN :**

Om de tafelbladen te beschermen mogen geen hete pannen, kaarsen of andere hete glazen op het oppervlakte geplaatst worden, gebruik hiervoor een beschermende onderligger.  
 Reinigen van oppervlaktes : met licht vochtige doek of zeemvel reinigen en direct droog wrijven. Zeker geen vocht laten staan op de oppervlaktes. Gebruik van ruwe materialen zoals schuurpons, schuurmiddelen, chemische producten zoals verduunners ammoniak of boenwas zijn niet toegelaten. Ook geen siliconen houdende producten aanwenden zoals pledge enz.  
 Garantie : Indien bovenstaande voorschriften niet gevolgd worden vervalt de garantie.









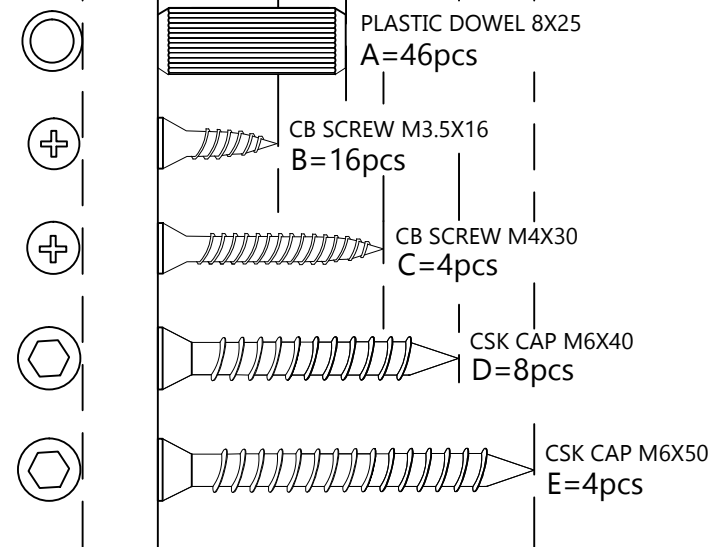
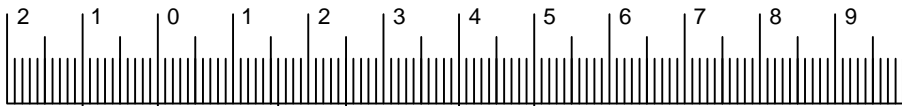

**INFORMATION GENERALE D'ENTRETIEN :**

Pour la protection de la surface des tables et autres éviter de mettre des casseroles chaudes ainsi que des bougies ou verres chaudes (thé) sur la surface sans protection.  
 L'entretien des surfaces : Utilisez un chiffon légèrement humide et séchez aussitôt. Jamais laisser des liquides sur les surfaces, les meubles ne sont pas adaptés pour un emplacement dans des pièces humides. Des éponges abrasives, tout produits chimiques : ammoniac, détergent, diluent; ou cirage et produits d'entretien comme Pledge sont interdit. Garantie : La garantie expire si les prescriptions d'entretien générale ne sont pas respecter.

**MAINTENANCE PRESCRIPTIONS :**

To protect the table tops never put hot items on these surfaces. Clean with a slightly wet cloth and wipe dry immediately. Never let water or other wet items on the table tops, this furniture is not suitable for wet locations. Do not use solvent, thinner, or other chemical products to clean.  
 Warranty : Expires if above prescriptions are not respected.

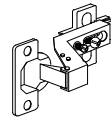

<b>F1</b>  MINIFIX 5654 (SCREW) 22pcs	<b>F2</b>  MINIFIX 5654 (HOUSING) 22pcs	<b>G</b>  METAL SHELF SUPPORT 12pcs	<b>H</b>  CAP 12pcs	<b>I</b>  PLASTIC PIN 6pcs	<b>J</b>  POWER NAIL 7/8" 38pcs
<b>K</b>  METAL HANDLE RA01835 (COOPER) 2pcs	<b>L</b>  HANDLE SCREW M4X22 2pcs	<b>M</b>  HINGES 7/8" 4pcs	<b>N</b>  ALLEN KEY 1pc		

### STEP 1

**A**

46x

PLASTIC DOWEL M8X25  
46 pcs

### STEP 2

**F1**

22x

MINIFIX 5654 (SCREW)  
22 pcs

Bottom View

Inside View

### STEP 3

**G**

12x

METAL SHELF SUPPORT  
12 pcs

### STEP 4

**F2**

8x

MINIFIX 5654 (HOUSING)  
8 pcs

**H**

CAP  
8 pcs

**N**

ALLEN KEY  
1 pc

### STEP 5

**D**

4x

CSK CAP M6X40  
4 pcs

**N**

ALLEN KEY  
1 pc

### STEP 6

**D**

4x

CSK CAP M6X40  
4 pcs

**N**

ALLEN KEY  
1 pc

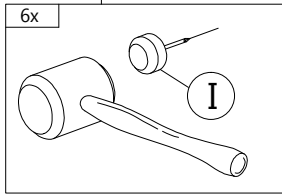
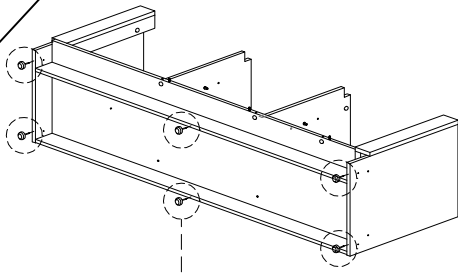

**STEP 7**



**I**  
  
 PLASTIC PIN  
 6 pcs

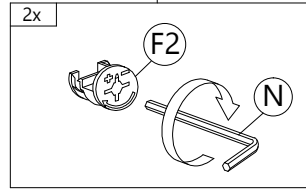
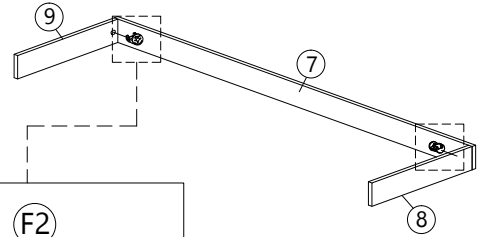

**STEP 8**

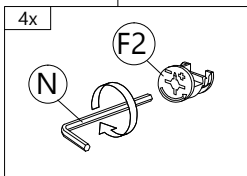
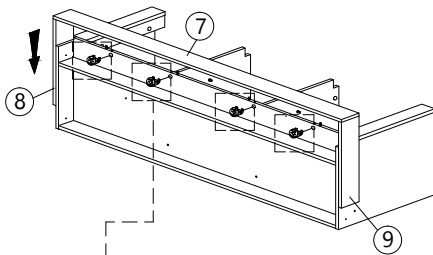

<b>F2</b>  MINIFIX 5654 (HOUSING) 2 pcs	<b>N</b>  ALLEN KEY 1 pc
---	--

**STEP 9**



<b>F2</b>  MINIFIX 5654 (HOUSING) 4 pcs	<b>N</b>  ALLEN KEY 1 pc
---	--

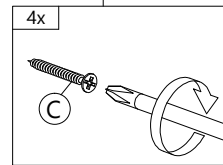
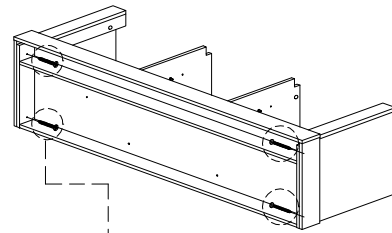

**STEP 10**



<b>C</b>  CB SCREW M4X30 4 pcs
--

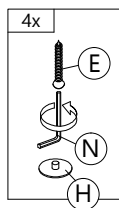
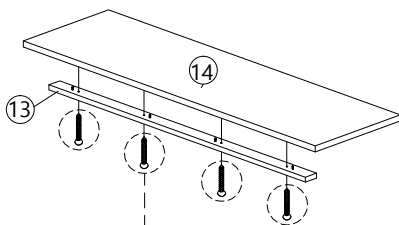

**STEP 11**

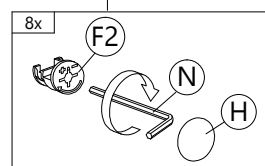
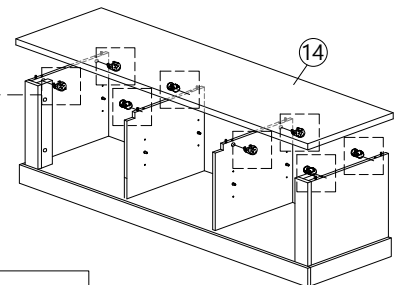

<b>E</b>  CSK CAP M6X50 4 pcs	<b>H</b>  CAP 4 pcs	<b>N</b>  ALLEN KEY 1 pc
---	---	--

**STEP 12**



<b>F2</b>  MINIFIX 5654 (HOUSING) 8 pcs	<b>H</b>  CAP 8 pcs	<b>N</b>  ALLEN KEY 1 pc
---	---	--

# STEP 13

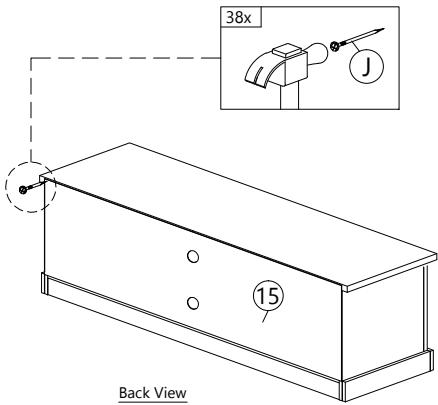

Back View

**J**  
  
 POWER NAIL 5/8"  
 38 pcs

# STEP 14

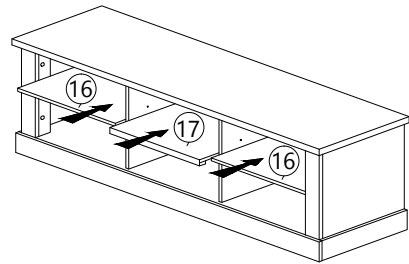

# STEP 15

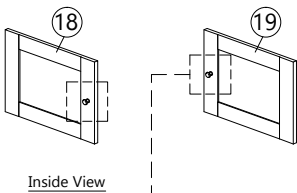

Inside View

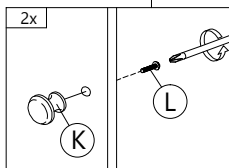

**K**  
  
 RA01835-METAL (COOPER)  
 2 pcs

**L**  
  
 HANDLE SCREW M4X22  
 2 pcs

# STEP 16

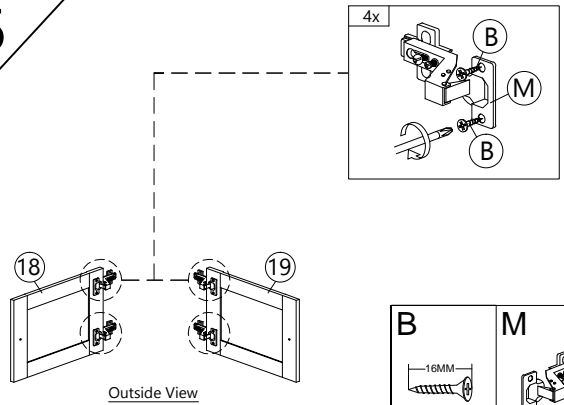



Outside View

**B**  
  
 CB SCREW M3.5X16  
 8 pcs

**M**  
  
 HINGES 7/8"  
 4 pcs

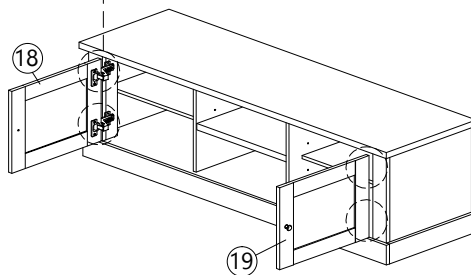
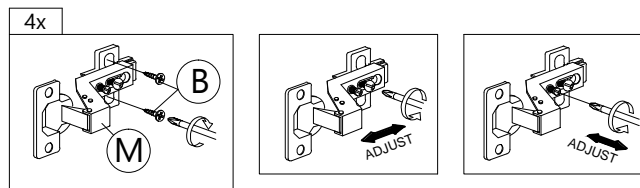
# STEP 17



**B**  
  
 CB SCREW M3.5X16  
 8 pcs